

Statistical Mechanics

Dr Alfred Huan

Contents

1	What is Statistical Mechanics?	3
1.1	Key Ideas in the module	3
1.2	Why do we study Statistical Mechanics?	4
1.3	Definitions	4
1.3.1	Microstate	4
1.3.2	Macrostate	5
2	Distribution Law	6
2.1	Distribution Law & Ensemble Approaches	6
2.2	Computation of Most Probable Macrostate Distribution, n_j	7
2.3	Problems in Derivation of Maxwell-Boltzmann Distribution	11
2.3.1	n_j not being always large	11
2.3.2	What about the other macrostates?	11
2.3.3	What happens when we have many energy levels?	14
2.4	Time Evolution of system of microstates	15
2.5	Alternative Derivation for Maxwell-Boltzmann Distribution	16
2.6	Examples of Counting in Statistical Mechanics	17
3	Indistinguishable Particles	20
3.1	Introduction	20
3.2	Bose-Einstein Distribution for Bosons	21
3.3	Fermi-Dirac Distribution for Fermions	23
3.4	Alternative Derivation for Bose-Einstein and Fermi-Dirac Statistics	24
4	Statistical Mechanics and Thermodynamic Laws	26
4.1	First Law	26
4.2	Second Law	27
4.3	Third Law	29
4.4	Calculation of Other Thermodynamic Variables	30
5	Applications of Maxwell-Boltzmann Statistics	33
5.1	Classical Perfect Gas	33
5.2	Harmonic Oscillator	39
5.3	Equipartition Theorem	40
6	Paramagnetic Systems	42
6.1	Introduction	42
6.2	Spin $\frac{1}{2}$ Quantum System	43
6.3	Spin J Quantum System	45

6.4	Adiabatic Cooling	49
7	Applications of Fermi-Dirac Statistics	51
7.1	Fermi-Dirac Distribution	51
7.2	Free Electron Model of Metals	53
8	Applications of Bose-Einstein Statistics	59
8.1	Introduction to Black Body Radiation	59
8.2	Bose-Einstein Distribution	60
8.3	Planck's Radiation Formula	61
8.4	Radiation emitted by blackbody	63
9	The Classical Limit	66
9.1	The Classical Regime	66
9.2	Monatomic Gas	67
9.3	Gibbs Paradox	69
10	Kinetic Theory of Gases	71
10.1	Introduction	71
10.2	Number of impacts on Area A of a wall	73
10.3	Effusion of molecules	74
10.4	Mean Free Path, λ	75
10.5	Collision cross-section, σ	76

Chapter 1

What is Statistical Mechanics?

1.1 Key Ideas in the module

We begin with the introduction of some important ideas which are fundamental in our understanding of statistical mechanics. The list of important terms are as follows :

1. Microstate
2. Macrostate
3. Partition Function
4. Derivation of Thermodynamic laws by Statistical Mechanics
5. The idea of interaction
 - (a) particle (system) - external environment
 - (b) particle (within a system of many particles)
6. Entropy : Disorder Number
7. Equipartition Theorem : the energies are distributed equally in different degrees of freedom.
8. Temperature
9. Distributions : Maxwell-Boltzmann, Fermi-Dirac, Bose-Einstein

In the 3rd year course, we shall restrict to equilibrium distributions, and static macroscopic variables. We will deal with single particle states and no ensembles, weakly interacting particles and the behaviour for distinguishable (degeneracies) and indistinguishable particles.

1.2 Why do we study Statistical Mechanics?

We apply statistical mechanics to solve for real systems (a system for many particles). We can easily solve the Schrodinger's equation for 1 particle/atom/molecule. For many particles, the solution will take the form :

$$\psi_{\text{total}} = \text{linear combination of } \psi_a(1)\psi_b(2)\psi_c(3)\dots$$

where ψ_a means a particle in state a with an energy E_a .

For example, we consider particles confined in a cubic box of length L . From quantum mechanics, the possible energies for each particle is :

$$E = \frac{\hbar^2 \pi^2}{2m L^2} (n_x^2 + n_y^2 + n_z^2)$$

For example in an ideal gas, We assume that the molecules are non-interacting, i.e. they do not affect each other's energy levels. Each particle contains a certain energy. At $T > 0$, the system possesses a total energy, E . So, how is E distributed among the particles? Another question would be, how the particles are distributed over the energy levels. We apply statistical mechanics to provide the answer and thermodynamics demands that the entropy be maximum at equilibrium.

Thermodynamics is concerned about heat and the direction of heat flow, whereas statistical mechanics gives a microscopic perspective of heat in terms of the structure of matter and provides a way of evaluating the thermal properties of matter, for e.g., heat capacity.

1.3 Definitions

1.3.1 Microstate

A **Microstate** is defined as *a state of the system where all the parameters of the constituents (particles) are specified*

Many microstates exist for each state of the system specified in macroscopic variables (E, V, N, \dots) and there are many parameters for each state. We have 2 perspectives to approach in looking at a microstate :

1. Classical Mechanics

The position (x, y, z) and momentum (P_x, P_y, P_z) will give $6N$ degrees of freedom and this is put in a phase space representation.

2. Quantum Mechanics

The energy levels and the state of particles in terms of quantum numbers are used to specify the parameters of a microstate.

1.3.2 Macrostate

A **Macrostate** is defined as a state of the system where the distribution of particles over the energy levels is specified..

The macrostate includes what are the different energy levels and the number of particles having particular energies. It contains many microstates.

In the equilibrium thermodynamic state, we only need to specify 3 macroscopic variables (P,V,T) or (P,V,N) or (E,V,N), where P : pressure, V : Volume, T : Temperature, N : Number of particles and E : Energy. The equation of state for the system relates the 3 variables to a fourth, for e.g. for an ideal gas.

$$PV = NkT$$

We also have examples of other systems like magnetic systems (where we include M, the magnetization). However, the equilibrium macrostate is unknown from thermodynamics.

In statistical mechanics, the equilibrium tends towards a macrostate which is the most stable. The stability of the macrostate depends on the perspective of microstates. We adopt the **a priori assumption** which states *the macrostate that is the most stable contains the overwhelming majority of microstates*. This also gives the probabilistic approach in physics.

Chapter 2

Distribution Law

2.1 Distribution Law & Ensemble Approaches

The distribution law is dependent on how we define the system. There are three approaches in defining the system and we adopt the three ensemble approaches.

1. **Microcanonical Ensemble** : Isolated system with fixed energy, E and number of particles, N .
2. **Canonical Ensemble** : The system is in a heat bath, at constant temperature with fixed N .
3. **Grand Canonical Ensemble** : Nothing is fixed.

The **disorder number**, Ω is defined as the number of microstates available to a macrostate, and is very large for the equilibrium macrostate. The disorder number is related to entropy, which is maximum at equilibrium.

To enumerate Ω , we need to decide whether the particles are distinguishable or indistinguishable. If they are indistinguishable, every microstate is a macrostate.

Let us now consider independent particles, with energy levels fixed and the particles don't influence each other's occupation. The energy levels are fixed by each particle's interaction with its surroundings but not particle-particle interactions. Mutual interaction exist only for energy exchange (during collisions).

Each level \mathbf{j} has energy ε_j , degeneracy g_j , and occupation n_j .

Distinguishability : small and identical particles cannot be distinguished during collisions, i.e. non-localised. However, localised particles are distinguishable because they are fixed in space, the sites being distinguishable e.g. in a paramagnetic solid.

For an isolated system, the volume V , energy E and total number of particles, N are fixed.

$$N = \sum_j n_j$$

$$\text{Total } E = \sum_j n_j \varepsilon_j$$

The **A Priori assumption** states that all microstates of a given E are equally probable thus the equilibrium macrostate must have overwhelming Ω .

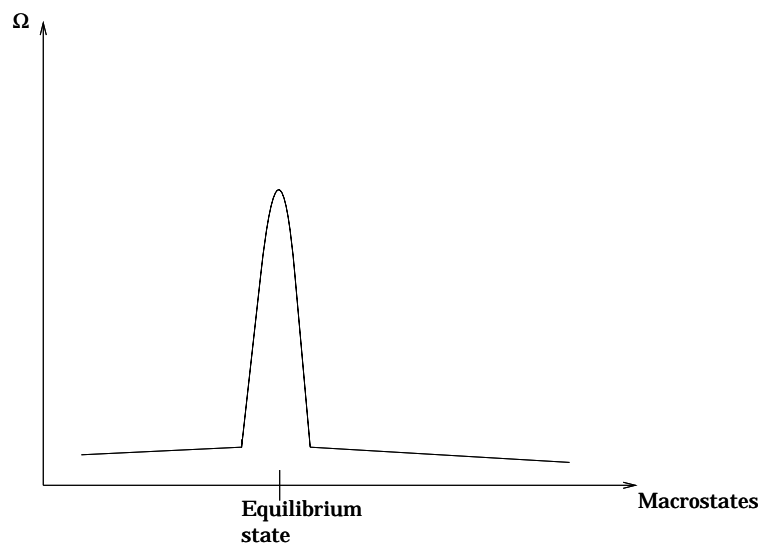

The disorder number Ω is proportional to thermodynamic probability, i.e. how probable for a particular macrostate to be the one corresponding to equilibrium.

2.2 Computation of Most Probable Macrostate Distribution, n_j

To find the n_j at equilibrium, i.e. we must find the most probable macrostate distribution. Considering the case for distinguishable particles :

1. Enumerate Ω . We distribute N particles over the energy levels: For example,
For the first level,

$$\text{The number of ways to assign } n_1 \text{ particles} = \frac{N!}{n_1!(N - n_1)!} \quad (2.1)$$

For the second level,

$$\text{The number of ways to assign } n_2 \text{ particles} = \frac{N - n_1!}{n_2!(N - n_1 - n_2)!} \quad (2.2)$$

$$\begin{aligned}
\text{Number of ways} &= \frac{N!}{n_1!(N-n_1!)} \times \frac{N-n_1!}{n_2!(N-n_1-n_2!)} \times \dots \\
&= \frac{N!}{n_1!n_2!\dots n_j!\dots} \\
&= \frac{N!}{\prod_j n_j!}
\end{aligned} \tag{2.3}$$

Level j has degeneracy g_j so any of the n_j particles can enter into any of the g_j levels.

$$\text{Number of ways} = g_j^{n_j} \tag{2.4}$$

For all levels,

$$\text{Number of ways} = \prod_j g_j^{n_j} \tag{2.5}$$

$$\text{Total } \Omega = N! \prod_j \frac{g_j^{n_j}}{n_j!} \tag{2.6}$$

2. Maximise Ω by keeping fixed E, N . These constraints are introduced through Lagrange multipliers.

For a fixed V , it means that the energy levels, ε_j are unchanged.

Maximise Ω subject to

$$\sum n_j = N$$

and

$$\sum n_j \varepsilon_j = E$$

At maximum,

$$d\Omega = 0 \tag{2.7}$$

$$\begin{aligned}
\Rightarrow d(\ln \Omega) &= \frac{1}{\Omega} d\Omega \\
&= 0
\end{aligned} \tag{2.8}$$

Hence we can choose to maximise $\ln \Omega$ instead of Ω

$$\ln \Omega = \ln N! + \sum_j n_j \ln g_j - \sum_j \ln n_j! \tag{2.9}$$

By Stirling's approximation for large N :

$$\ln N! = N \ln N - N \tag{2.10}$$

Proof :

$$\begin{aligned}
 \ln N! &= \sum_1^N \ln n \\
 &= \int_1^N \ln n \, dn \\
 &= [n \ln n - n]_1^N \\
 &= N \ln N - N + 1
 \end{aligned} \tag{2.11}$$

Or

$$\begin{aligned}
 \sum_1^N \ln n \, \Delta n &= \int_{\frac{1}{N}}^1 (N \ln \frac{n}{N} + N \ln N) d(\frac{n}{N}) \\
 &= N[x \ln x - x]_{\frac{1}{N}}^1 + N \ln N (1 - \frac{1}{N}) \\
 &= -N + \ln N + 1 + N \ln N - \ln N \\
 &= N \ln N - N + 1
 \end{aligned} \tag{2.12}$$

where $\Delta n = d(\frac{n}{N}) = dx$.

Now we come back to $\ln \Omega$

$$\begin{aligned}
 \ln \Omega &\approx N \ln N - N + \sum_j (n_j \ln g_j - n_j \ln n_j + n_j) \\
 &= N \ln N + \sum_j (n_j \ln g_j - n_j \ln n_j) \\
 &= N \ln N + \sum_j n_j \ln(\frac{g_j}{n_j})
 \end{aligned} \tag{2.13}$$

by assuming large n_j also, which is not always true.

$$d(\ln \Omega) = \sum_j (\ln \frac{g_j}{n_j} dn_j - dn_j) = 0 \tag{2.14}$$

It is subjected to the constraints :

$$\sum_j dn_j = 0 \text{ (for fixed N)}$$

$$\sum_j \varepsilon_j dn_j = 0 \text{ (for fixed E)}$$

Note ε_j does not vary. Therefore

$$\sum_j \ln(\frac{g_j}{n_j}) dn_j = 0 \tag{2.15}$$

Now we introduce the constraints :

$$\begin{aligned}\alpha \sum_j dn_j &= 0 \\ -\beta \sum_j \varepsilon_j dn_j &= 0\end{aligned}$$

so we get

$$\sum_j (\ln(\frac{g_j}{n_j}) + \alpha - \beta \varepsilon_j) dn_j = 0 \quad (2.16)$$

We choose α and β such that

$$\ln(\frac{g_j}{n_j}) + \alpha - \beta \varepsilon_j = 0 \quad (2.17)$$

The equilibrium macrostate becomes :

$$\begin{aligned}n_j &= g_j e^{\alpha} e^{-\beta \varepsilon_j} \\ &= \frac{N g_j}{\sum_j g_j e^{-\beta \varepsilon_j}} e^{-\beta \varepsilon_j} \\ &= \frac{N g_j}{Z} e^{-\beta \varepsilon_j} \quad (\text{Maxwell-Boltzmann Distribution})\end{aligned} \quad (2.18)$$

where z is the **partition function**

We will prove later that β is equal to $\frac{1}{kT}$ where k is the Boltzmann constant ($k = 1.38 \times 10^{-23} JK^{-1} mol^{-1}$) and T is the temperature.

For $\varepsilon_j > \varepsilon_i$, we get $n_j < n_i$ for $g_j = g_i$ and $T > 0$

For $T = 0$, $n_j = 0$, except for n_1 , i.e. all the particles are at ground state. For $T > 0$, the upper levels get piled by particles provided

$$\Delta \varepsilon \sim kT \quad (2.19)$$

Otherwise, the population of upper levels remain small.

In lasers, population inversion leads to negative temperature,

$$\begin{aligned}\frac{n_2}{n_1} &= \frac{g_2 e^{-\frac{\varepsilon_2}{kT}}}{g_1 e^{-\frac{\varepsilon_1}{kT}}} \\ &= \frac{e^{-\frac{\varepsilon_2}{kT}}}{e^{-\frac{\varepsilon_1}{kT}}} > 1\end{aligned} \quad (2.20)$$

for $g_1 = g_2$,

$$\begin{aligned}\Rightarrow e^{-\frac{\varepsilon_2}{kT}} &> e^{-\frac{\varepsilon_1}{kT}} \\ -\frac{\varepsilon_2}{kT} &> -\frac{\varepsilon_1}{kT} \\ -\frac{\varepsilon_2}{T} &> -\frac{\varepsilon_1}{T}\end{aligned} \quad (2.21)$$

because $k > 0$.

Since $\varepsilon_2 > \varepsilon_1$, then $T < 0$

2.3 Problems in Derivation of Maxwell-Boltzmann Distribution

There are 2 inherent problems present in the derivation of Maxwell-Boltzmann distribution :

1. n_j is not always large.
2. The other macrostates of the same fixed energy E . What are their Ω s? Are they small enough to be neglected?

The equilibrium distribution \tilde{n}_j should be weighted against Ω of all possible macrostates i , so

$$\tilde{n}_j = \frac{\sum_j n_j \Omega_i(n_j)}{\sum_j \Omega_i(n_j)} \quad (2.22)$$

The most probable \bar{n}_j (Maxwell-Boltzmann Distribution)

$$\bar{n}_j = \frac{N g_j e^{-\frac{\epsilon_j}{kT}}}{\sum_j g_j e^{-\frac{\epsilon_j}{kT}}} \quad (2.23)$$

2.3.1 n_j not being always large

If the total number of levels $\sum_j 1$ is small and T is large enough, then every level j has many particles so that for large n_j . Stirling's approximation can be used.

If many levels exist, the lower levels will have large n_j but higher levels will have small n_j . Many of the higher levels will give $\ln n_j! \approx 0$. (Note that $0! = 1! = 1$).

However, the higher levels contribute very negligibly to $\sum \ln n_j!$ so that we can approximate again by $\sum (n_j \ln n_j - n_j)$ because many of the lower levels have large n_j .

2.3.2 What about the other macrostates?

How does the Ω change when we consider other macrostates?

Consider the Ω changes from the most probable macrostate \bar{n}_j to another distribution n_j .

$$n_j = \bar{n}_j + \delta n_j \quad (2.24)$$

Since

$$\begin{aligned} \ln \Omega(n_j) &= N \ln N - N - \sum_j (n_j \ln n_j - n_j) \\ &= N \ln N - \sum_j n_j \ln n_j \end{aligned} \quad (2.25)$$

Expand about \bar{n}_j ,

$$\begin{aligned}
\ln \Omega(n_j) &= N \ln N - \sum_j (\bar{n}_j + \delta n_j) \ln(\bar{n}_j + \delta n_j) \\
&= N \ln N - \sum_j (\bar{n}_j + \delta n_j) \left(\ln \bar{n}_j + \ln \left(1 + \frac{\delta n_j}{\bar{n}_j} \right) \right) \\
&= N \ln N - \sum_j (\bar{n}_j + \delta n_j) \left(\ln \bar{n}_j + \frac{\delta n_j}{\bar{n}_j} - \frac{1}{2} \left(\frac{\delta n_j}{\bar{n}_j} \right)^2 + \dots \right) \\
&= N \ln N - \sum_j \bar{n}_j \ln \bar{n}_j + \delta n_j + \delta n_j \ln \bar{n}_j + \frac{1}{2} \left(\frac{\delta n_j}{\bar{n}_j} \right)^2 + \dots \\
&= \ln \Omega(\bar{n}_j) - \sum_j \delta n_j - \sum_j \delta n_j \ln \bar{n}_j - \frac{1}{2} \sum_j \frac{(\delta n_j)^2}{\bar{n}_j} + \dots
\end{aligned} \tag{2.26}$$

where

$$\bar{n}_j = \frac{N}{Z} e^{-\frac{\varepsilon_j}{kT}}$$

neglecting g_j for the purpose of simplifying the discussion.

Now as before,

$$\sum_j \delta n_j = 0$$

$$\text{and } \sum_j \delta n_j \varepsilon_j = 0$$

Thus,

$$\begin{aligned}
\ln \Omega(n_j) &= \ln \Omega(\bar{n}_j) - \sum_j \delta n_j \left(\ln \frac{N}{Z} - \frac{\varepsilon_j}{kT} \right) - \frac{1}{2} \sum_j \frac{(\delta n_j)^2}{\bar{n}_j} + \dots \\
&= \ln \Omega(\bar{n}_j) - \ln \frac{N}{Z} \sum_j \delta n_j + \frac{1}{kT} \sum_j \varepsilon_j \delta n_j - \frac{1}{2} \sum_j \frac{(\delta n_j)^2}{\bar{n}_j} + \dots \\
&= \ln \Omega(\bar{n}_j) - \frac{1}{2} \sum_j \frac{(\delta n_j)^2}{\bar{n}_j} + \dots
\end{aligned} \tag{2.27}$$

It follows that

$$\Omega(n_j) = \Omega(\bar{n}_j) e^{\frac{1}{2} \sum_j \frac{(\delta n_j)^2}{\bar{n}_j}} \tag{2.28}$$

$\Omega(n_j)$ will be small, if $\delta n_j \geq \sqrt{\bar{n}_j}$.

Since \bar{n}_j are large, the fluctuations allowed are very small, by comparison, e.g. if $n_j \approx 10^{20}$, $n_j \lesssim 10^{10}$ for $\Omega(n_j)$ to be large. Thus $\delta n_j \ll n_j$, so the fluctuation is minor.. Ultimately, in deriving properties of the system, minor fluctuations will not matter very much.

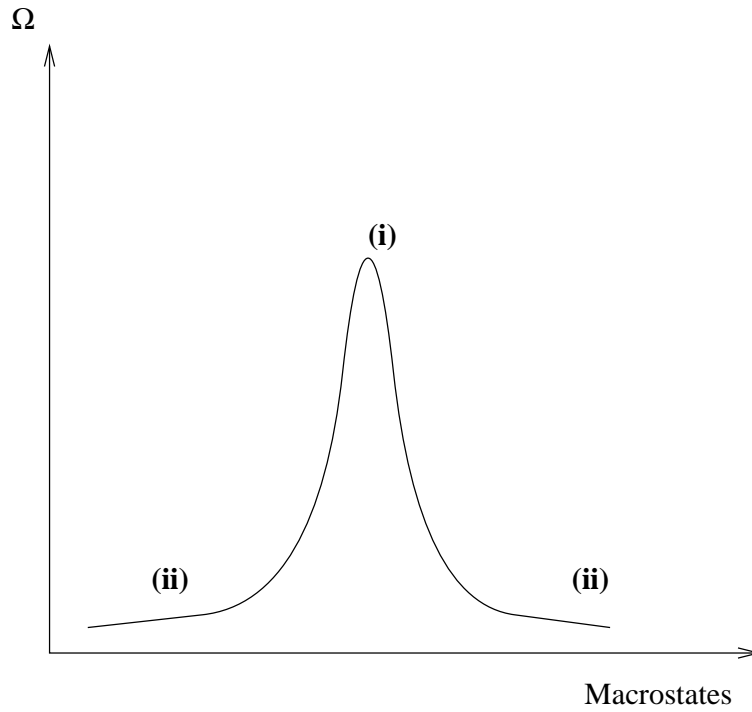

where (i) represents $\delta n_j \ll n_j$ and (ii) δn_j large.

Alternatively, we can also argue the problem out by the choice of a fractional deviation $\delta = \frac{|\delta n_j|}{\bar{n}_j}$, and we assume δ is the same for all j . Then,

$$\begin{aligned} \sum_j \frac{(\delta n_j)^2}{\bar{n}_j} &= \sum_j \delta^2 \bar{n}_j \\ &= \delta^2 N \end{aligned} \tag{2.29}$$

Hence

$$\Omega(n_j) = \Omega(\bar{n}_j) e^{-\delta^2 N} \tag{2.30}$$

which is small unless $\delta^2 \lesssim \frac{1}{N}$, i.e.,

$$|\delta n_j| \lesssim \frac{\bar{n}_j}{\sqrt{N}} < 1 \tag{2.31}$$

so δn_j needs to be small in order for $\Omega(n_j)$ to be significantly large. In either case, we see that $\Omega(n_j)$ will be small when the fluctuation δn_j is large

Now we come back to the total number of macrostates :

The total number of macrostates consistent with constraints :

$$\begin{aligned} \sum \Omega &\sim \Omega(\bar{n}_j) \int e^{\frac{-\delta n_1^2}{\bar{n}_1}} d\delta n_1 \int e^{\frac{-\delta n_2^2}{\bar{n}_2}} d\delta n_2 \dots\dots \\ &= \Omega(\bar{n}_j) \prod_j (\bar{n}_j)^{\frac{1}{2}} \end{aligned} \tag{2.32}$$

Stopping the product when $\bar{n}_j = 1$

If total number of energy levels, G is very much less than N , then $n_j \sim \frac{N}{G}$ and $j = 1, 2, \dots, G$.

$$\sum \Omega \sim \Omega(\bar{n}_j) \left(\frac{N}{G}\right)^{\frac{G}{2}} \tag{2.33}$$

$$\ln \sum \Omega \sim \ln \Omega(\bar{n}_j) + \frac{G}{2} \ln N - \frac{G}{2} \ln G \tag{2.34}$$

Now

$$\ln \Omega(\bar{n}_j) \approx N \ln N \gg \ln N \gg \ln G \tag{2.35}$$

so

$$\ln \sum \Omega \approx \ln \Omega(\bar{n}_j) \tag{2.36}$$

so the most probable microstate has overwhelming Ω .

2.3.3 What happens when we have many energy levels?

If $n_j \sim 1$ for most levels, then we have many energy levels $G \gg N$. This means that all macrostates look roughly the same.

The total number of microstates are not mainly due to the maximum term $\Omega(\bar{n}_j)$, i.e. $\sum \Omega \neq \Omega(\bar{n}_j)$. Hence Stirling's approximation is invalid in this case.

We resort to the following trick : Energy levels are closely spaced in groups because G is large. They are grouped into bunches of g_i with m_i occupation. g_i and m_i can be made large in this case.

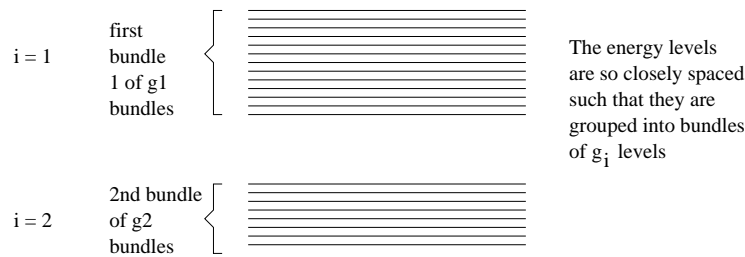

Using the previous derivation by counting $\Omega(\bar{m}_i$ energy states),

$$\begin{aligned} \bar{m}_i &= \frac{N g_i e^{-\frac{\epsilon_i}{kT}}}{\sum_j g_j e^{-\frac{\epsilon_j}{kT}}} \\ &= \frac{N g_i e^{-\frac{\epsilon_i}{kT}}}{\sum_j e^{-\frac{\epsilon_j}{kT}}} \end{aligned} \tag{2.37}$$

We take the time average value of n_j over a large number of different macrostates.

$$\begin{aligned}\bar{m}_i &= \frac{\bar{m}_i}{g_i} \\ &= \frac{N e^{-\frac{\epsilon_j}{kT}}}{\sum_j e^{-\frac{\epsilon_j}{kT}}}\end{aligned}\quad (2.38)$$

$$\Omega(\bar{m}_i) = N! \prod_i \frac{g_i^{m_i}}{m_i!} \quad (2.39)$$

$$\ln \Omega(\bar{n}_j) = \ln \sum \Omega \quad (2.40)$$

By grouping closely spaced levels, the time-averaged variations are small and the Maxwell-Boltzmann distribution describes \bar{n}_j very well. Otherwise with $n_j \sim 1$, the variation at each j level appears large. The treatment tries to obtain the average \bar{n}_i over many different but similar macrostates.

After a series of attack on our fundamental assumptions, we come to establish the basis of statistical mechanics : **All macrostates of significant probability (i.e. large Ω) have roughly the same properties and distribution close to the Maxwell-Boltzmann distribution ignoring minor changes.**

2.4 Time Evolution of system of microstates

How many microstates does the system explore within the time for the experiment?

For example, we consider paramagnetic system (where the atomic spins interact with the external magnetic field - Zeeman Effect). The particles inside this system ($= 10^{23}$ particles) are assumed to be non-interacting, and each electron have a spin of $\pm \frac{1}{2}$. We also fix E and T for a fixed macrostate i.e. n_j . Note in Quantum Mechanics, the energy levels are discretized.

$$\sum_k \mu_k \cdot B_k \equiv E \equiv f(T) \text{ k - each atom}$$

The change in microstates will mean that the spin energy of the electron is exchanged between neighbouring atoms so the atoms interchange energy levels. The typical time for spin flip is 10^{-12} s. So for 10^{23} electrons :

$$\text{The Transition Speed} = 10^{12} \times 10^{23} = 10^{35} \text{ s}^{-1}$$

Now, the number of microstates :

$$\Omega \sim e^{N \ln N} > e^{10^{35}} \gg \gg 10^{35}$$

So it takes forever to go through all the microstates. Hence, for every experiment, one can only explore a small proportion of microstates. So we need a statistical assumption that what we observe corresponds to the real average over all microstates.

2.5 Alternative Derivation for Maxwell-Boltzmann Distribution

We present an alternative method to derive Maxwell-Boltzmann distribution from the perspective of equilibrium.

Suppose we change from 1 macrostate to another macrostate, keeping E , V and N fixed. We need a transition from i to k to be accompanied by another transition from j to l .

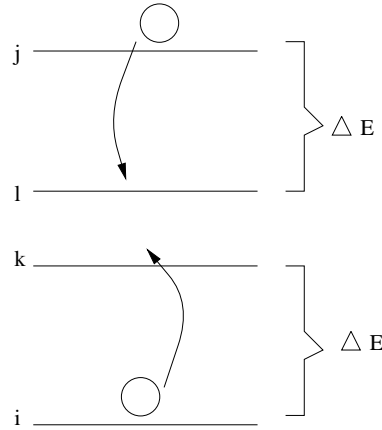

Both the transitions from j to l or i to k requires the same amount of energy.

Therefore, the rate

$$R_{i \rightarrow k l} = N_i N_j T_{i j \rightarrow k l} \quad (2.41)$$

where $T_{i j \rightarrow k l}$ is the transition probability.

The total rate out from level i :

$$R_{i \text{ out}} = N_i \sum_{j, k, l} N_j T_{i j \rightarrow k l} \quad (2.42)$$

The total rate in to level i :

$$R_{i \text{ in}} = \sum_{j, k, l} N_k N_l T_{k l \rightarrow i j} \quad (2.43)$$

At equilibrium,

$$R_{i \text{ out}} = R_{i \text{ in}} \quad (2.44)$$

Therefore it follows that :

$$N_i \sum_{j, k, l} N_j T_{i j \rightarrow k l} = \sum_{j, k, l} N_k N_l T_{k l \rightarrow i j} \quad (2.45)$$

Now we invoke the time-reversal invariance, which is true for almost all transitions,

$$T_{k l \rightarrow i j} = T_{i j \rightarrow k l} \quad (2.46)$$

Thus for every combination i, j, k and l , we require

$$N_i N_j = N_k N_l \text{ (Principle of Detailed Balancing)} \tag{2.47}$$

or

$$\ln N_i + \ln N_j = \ln N_k + \ln N_l \tag{2.48}$$

and

$$\varepsilon_i + \varepsilon_j = \varepsilon_k + \varepsilon_l \tag{2.49}$$

is required for energy conservation.

Since $N_i \equiv N(\varepsilon_i)$, both equations will lead to

$$\ln N_i = -\beta\varepsilon_i + \alpha \tag{2.50}$$

$$N_i = e^\alpha e^{-\beta\varepsilon_i} \tag{2.51}$$

which is the Maxwell-Boltzmann Distribution.

2.6 Examples of Counting in Statistical Mechanics

Problem 1 :

Given 6 distinguishable particles, 2 energy levels (one with a degeneracy of 2 and the other degeneracy of 5). We want to calculate the number of macrostates and microstates in this system.

First of all, we present a diagrammatic scheme of the problem :

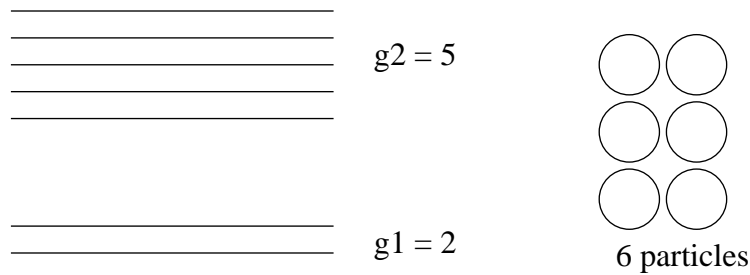

We also note importantly *that there are no equilibrium macrostate in this problem because all the macrostates have different total energies.*

There are 7 macrostates namely : $(6,0), (5,1), (4,2), (3,3), (2,4), (1,5)$ and $(0,6)$.

Now we come to calculate the microstates :

For $(6,0)$ macrostate,

$$\Omega = 2^6 \text{ ways}$$

For (5,1) macrostate,

$$\begin{aligned}\Omega &= \frac{N!}{n_1!n_2!}g_1^{n_1}g_2^{n_2} \\ &= \frac{6!}{5!1!} \times 2^5 \times 5 \text{ ways}\end{aligned}$$

Subsequently, we can calculate for the remaining macrostates, using the example above.

Problem 2 :

Given 5 energy levels, each separated by ΔE . We consider the particles to be weakly interacting, i.e. they exchange energy but do not affect each other's energy levels. Let us look at the first 3 levels : (i) a particle moves from the 3rd level down to the 2nd level and (ii) a particle moves from 1st level to the 2nd level. In this case, the change in energy is balanced by exchange of particles for the 2 processes. Hence we can talk about a fixed macrostate. Now we try to calculate Ω

Now we consider the schematic picture of this problem :

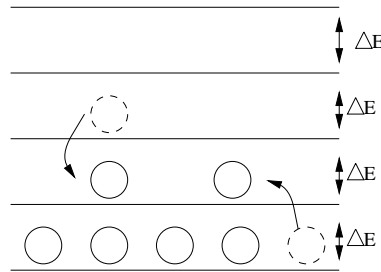

$$\begin{aligned}\text{Macrostate } (5,0,1,0,0), \Omega_1 &= {}^6C_5 \times {}^1C_0 \times {}^1C_1 \times {}^0C_0 \times {}^0C_0 \\ &= 6 \text{ ways}\end{aligned}$$

$$\begin{aligned}\text{Macrostate } (4,2,0,0,0), \Omega_2 &= {}^6C_4 \times {}^2C_2 \times {}^0C_0 \times {}^0C_0 \times {}^0C_0 \\ &= 15 \text{ ways}\end{aligned}$$

At equilibrium, we apply the weighted average for microstates, because the number of microstates in either macrostate is not overwhelming enough.

$$\tilde{n}_j = \frac{\sum n_j \Omega_i(n_j)}{\sum \Omega_i} \tag{2.52}$$

Therefore,

$$\begin{aligned}\tilde{n}_1 &= \frac{5 \times 6 + 4 \times 15}{6 + 15} \\ &= \frac{90}{21}\end{aligned}$$

$$\begin{aligned}\tilde{n}_2 &= \frac{0 \times 6 + 2 \times 15}{6 + 15} \\ &= \frac{30}{21}\end{aligned}$$

$$\begin{aligned}\tilde{n}_3 &= \frac{1 \times 6 + 0 \times 15}{6 + 15} \\ &= \frac{6}{21}\end{aligned}$$

$$\tilde{n}_4 = 0$$

$$\tilde{n}_5 = 0$$

Note :

$$\sum_j \tilde{n}_j = 6$$

which is the same as $\sum n_j$ for any macrostate.

Chapter 3

Indistinguishable Particles

3.1 Introduction

Why are particles indistinguishable?

This is a quantum mechanical effect. The exchange of quantum particles cannot be detected. The ψ 's of the individual particles combine to form a total ψ , and they are non-localised.

We can write a many particle wavefunction Ψ as a linear combination of $\psi_a(1)\psi_b(2)\dots$ plus all the possible permutations. For example, for three particle permutations, we get six possibilities :

$$\begin{aligned} &\psi_a(2)\psi_b(1)\psi_c(3)\dots \\ &\psi_a(2)\psi_b(3)\psi_c(1)\dots \\ &\psi_a(1)\psi_b(3)\psi_c(2)\dots \\ &\text{etc.} \end{aligned}$$

All particles are identical so all permutations are solutions to Schrodinger's equations, and so are all linear combination of the permutations.

There are two physically meaningful solutions.

1. Symmetric ψ :

$$\psi_s = \sum_p P[\psi(1, 2, \dots, N)] \quad (3.1)$$

E.g. for 3 particles, we get

$$\begin{aligned} \psi_s = &\psi_a(1)\psi_b(2)\psi_c(3) + \psi_a(2)\psi_b(1)\psi_c(3) + \psi_a(3)\psi_b(2)\psi_c(1) \\ &+ \psi_a(1)\psi_b(3)\psi_c(2) + \psi_a(2)\psi_b(3)\psi_c(1) + \psi_a(3)\psi_b(1)\psi_c(2) \end{aligned}$$

2. Antisymmetric ψ

$$\psi_a = \sum_p (-1)^p P[\psi(1, 2, \dots, N)] \quad (3.2)$$

where P is the *permutation operator*; $(-1)^P$ means $\times(-1)$ every time we exchange two particle states.

E.g., for 3 particles, we get

$$\begin{aligned}\psi_s &= \psi_a(1)\psi_b(2)\psi_c(3) - \psi_a(2)\psi_b(1)\psi_c(3) - \psi_a(3)\psi_b(2)\psi_c(1) \\ &\quad - \psi_a(1)\psi_b(3)\psi_c(2) + \psi_a(2)\psi_b(3)\psi_c(1) + \psi_a(3)\psi_b(1)\psi_c(2)\end{aligned}$$

If we exchange 1 and 2, then $\psi_a(2, 1, 3) = -\psi_a(1, 2, 3)$

There are two kinds of quantum particles in nature:

1. Bosons : Symmetric wavefunctions with integral spins.
2. Fermions : Anti-symmetric wavefunctions with half-integral spins.

Note when 2 fermions are in the same state, total ψ is zero. For example, $\psi_a = \psi_b$, meaning all permutations cancel in pairs, and hence we obtain Pauli's Exclusion Principle.

3.2 Bose-Einstein Distribution for Bosons

There is no limit to the occupation number at each level of quantum state. In fact, the more the better. Note that $\Omega = 1$ for all macrostates because of the indistinguishability of particles. (Macrostates \equiv Microstates)

Unless $g \gg 1$ for some levels, for example, by the clumping of levels together to make g_i large. We can then count microstates ($\Omega \gg 1$) because the states in i are distinguishable.

To put m_i particles in g_i states, imagine arranging m_i particles into g_i states, by arranging m_i identical particles and $g_i - 1$ identical barriers on a straight line.



$$\text{The number of ways} = \frac{(m_i + g_i - 1)!}{m_i!(g_i - 1)!} \quad (3.3)$$

Therefore,

$$\Omega = \frac{(m_i + g_i - 1)!}{m_i!(g_i - 1)!} \quad (3.4)$$

To maximise subject to the constraints :

$$\begin{aligned}\sum_i m_i &= N \\ \sum_i m_i \varepsilon_i &= E\end{aligned}$$

Therefore,

$$\begin{aligned}
\ln \Omega &= \sum_i [\ln(m_i + g_i - 1)! - \ln m_i! - \ln(g_i - 1)!] \\
&\approx \sum_i [(m_i + g_i - 1) \ln(m_i + g_i - 1) - (m_i + g_i - 1) - m_i \ln m_i + m_i - (g_i - 1) \ln(g_i - 1) - (g_i - 1)] \\
&\approx \sum_i [(m_i + g_i) \ln(m_i + g_i) - m_i \ln m_i - g_i \ln g_i]
\end{aligned} \tag{3.5}$$

for $g_i, m_i \gg 1$

$$d(\ln \Omega) = \sum_i dm_i \ln(m_i + g_i) + dm_i - dm_i \ln m_i - dm_i = 0 \tag{3.6}$$

$$\sum_i \left(\ln \frac{m_i + g_i}{m_i} \right) dm_i = 0 \tag{3.7}$$

Add in :

$$\begin{aligned}
\alpha \sum_i dm_i &= 0 \\
-\beta \sum_i \varepsilon_i dm_i &= 0
\end{aligned}$$

So

$$\sum_i \left(\ln \left(\frac{m_i + g_i}{m_i} \right) + \alpha - \beta \varepsilon_i \right) dm_i = 0 \tag{3.8}$$

Then,

$$\frac{m_i + g_i}{m_i} = e^{-\alpha} e^{\beta \varepsilon_i} \tag{3.9}$$

Therefore,

$$m_i = \frac{g_i}{e^{-\alpha} e^{\beta \varepsilon_i} - 1} \tag{3.10}$$

where $\beta = \frac{1}{kT}$ (to be proved later).

Averaging over the g_i levels in each clump,

$$n_j = \frac{1}{e^{-\alpha} e^{\beta \varepsilon_j} - 1} \tag{3.11}$$

which is the Bose-Einstein Distribution.

We will find later that $\alpha = \frac{\mu}{kT}$ where μ is the chemical potential. Two systems at thermodynamic equilibrium have the same temperature T . The systems at chemical (particle number) equilibrium have the same μ .

3.3 Fermi-Dirac Distribution for Fermions

In this case, we allow 0 or 1 particle to each quantum state.

Now we clump the energy levels to produce g_i states and m_i ($\ll g_i$).

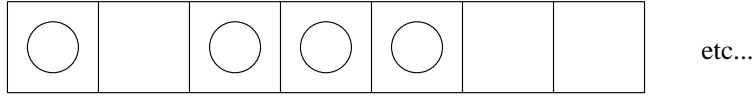

Either there is a particle or no particle in each quantum state.

$$\text{Number of ways to fill } m_i \text{ boxes out of } g_i = \frac{g_i!}{m_i!(g_i - m_i)!} \quad (3.12)$$

Therefore

$$\Omega = \prod_i \frac{g_i!}{m_i!(g_i - m_i)!} \quad (3.13)$$

To maximise subject to the constraints :

$$\begin{aligned} \sum_i m_i &= N \\ \sum_i m_i \varepsilon_i &= E \end{aligned}$$

Therefore,

$$\ln \Omega \approx \sum_i g_i \ln g_i - m_i \ln m_i - (g_i - m_i) \ln(g_i - m_i) \quad (3.14)$$

where $g_i \gg m_i \gg 1$

$$\begin{aligned} d \ln \Omega &= \sum_i -dm_i \ln m_i - dm_i + dm_i \ln(g_i - m_i) + dm_i \\ &= \sum_i \ln\left(\frac{g_i - m_i}{m_i}\right) dm_i \\ &= 0 \end{aligned} \quad (3.15)$$

Now we add in :

$$\begin{aligned} \alpha \sum_i dm_i &= 0 \\ -\beta \sum_i \varepsilon_i dm_i &= 0 \end{aligned}$$

So

$$\sum_i \left(\ln\left(\frac{g_i - m_i}{m_i}\right) + \alpha - \beta \varepsilon_i \right) dm_i = 0 \quad (3.16)$$

Then,

$$\frac{g_i - m_i}{m_i} = e^{-\alpha} e^{\beta \varepsilon_i} \quad (3.17)$$

Therefore,

$$m_i = \frac{g_i}{e^{-\alpha} e^{\beta \varepsilon_i} + 1} \quad (3.18)$$

Averaging over the g_i levels in each clump,

$$n_j = \frac{1}{e^{-\alpha} e^{\beta \varepsilon_j} + 1} \quad (3.19)$$

which is the Fermi-Dirac Distribution.

Note :

1) The positive sign in Fermi-Dirac distribution implies that $\bar{n}_j \leq 1$ which is Pauli Exclusion principle (which states that no 2 fermions can share the same quantum state).

2) If $\sum n_j = N$ is not a constraint, μ is zero and this is true for open systems. For isolated systems with fixed N, μ has a value.

3.4 Alternative Derivation for Bose-Einstein and Fermi-Dirac Statistics

For equilibrium consideration, $T_{ij \rightarrow kl}$ is the transition rate from $i \rightarrow k$ accompanied by $j \rightarrow l$ to maintain energy conservation.

Suppose the rate depends on the occupation at k and l,

$$Ri_{out} = N_i \sum_{j,k,l} N_j T_{ij \rightarrow kl} (1 \pm N_k)(1 \pm N_l) \quad (3.20)$$

$$\begin{aligned} Ri_{in} &= \sum_{j,k,l} N_k N_l T_{kl \rightarrow ij} (1 \pm N_i)(1 \pm N_j) \\ &= (1 \pm N_i) \sum_{j,k,l} N_k N_l T_{kl \rightarrow ij} (1 \pm N_j) \end{aligned} \quad (3.21)$$

At equilibrium,

$$N_i \sum_{j,k,l} N_j T_{ij \rightarrow kl} (1 \pm N_k)(1 \pm N_l) = (1 \pm N_i) \sum_{j,k,l} N_k N_l T_{kl \rightarrow ij} (1 \pm N_j) \quad (3.22)$$

Applying time-reversal invariance,

$$T_{ij \rightarrow kl} = T_{kl \rightarrow ij} \quad (3.23)$$

Then for every combination i, j, k, l , we need

$$N_i N_j (1 \pm N_k)(1 \pm N_l) = N_k N_l (1 \pm N_i)(1 \pm N_j) \quad (3.24)$$

So

$$\frac{N_i}{1 \pm N_i} \frac{N_j}{1 \pm N_j} = \frac{N_k}{1 \pm N_k} \frac{N_l}{1 \pm N_l} \quad (3.25)$$

$$\ln \frac{N_i}{1 \pm N_i} + \ln \frac{N_j}{1 \pm N_j} = \ln \frac{N_k}{1 \pm N_k} + \ln \frac{N_l}{1 \pm N_l} \quad (3.26)$$

with

$$\varepsilon_i + \varepsilon_j = \varepsilon_k + \varepsilon_l \quad (3.27)$$

which is the conservation of energy. Therefore

$$\ln \frac{N_i}{1 \pm N_i} = \alpha - \beta \varepsilon_i \quad (3.28)$$

then,

$$\frac{N_i}{1 \pm N_i} = e^\alpha e^{-\beta \varepsilon_i} \quad (3.29)$$

$$N_i \mp N_i e^\alpha e^{-\beta \varepsilon_i} = e^\alpha e^{-\beta \varepsilon_i} \quad (3.30)$$

$$N_i = \frac{1}{e^{-\alpha} e^{\beta \varepsilon_i} \mp 1} \quad (3.31)$$

So starting with the positive (+) sign, we obtain

$$N_i = \frac{1}{e^{-\alpha} e^{\beta \varepsilon_i} + 1} \text{ Fermi-Dirac Distribution} \quad (3.32)$$

and with the negative (-) sign, we obtain

$$N_i = \frac{1}{e^{-\alpha} e^{\beta \varepsilon_i} - 1} \text{ Bose-Einstein Distribution} \quad (3.33)$$

For fermions, the rate $Ri_{out} \propto (1 - N_k)(1 - N_l)$ which demonstrates Pauli's Exclusion Principle, and for bosons, the rate $Ri_{out} \propto (1 + N_k)(1 - N_l)$, i.e. the more particles in k and l , the more likely the transition. (The more you have, the more you receive).

Chapter 4

Statistical Mechanics and Thermodynamic Laws

4.1 First Law

The First law of Thermodynamics :

$$dU = dQ + dW \quad (4.1)$$

In Statistical Mechanics :

$$\text{Total Energy, } E = U = \sum_j n_j \varepsilon_j \quad (4.2)$$

Therefore

$$dU = \sum_j \varepsilon_j dn_j + \sum_j n_j d\varepsilon_j \quad (4.3)$$

Now, we have $dW = -PdV$ or $\mu_0 H dm$ etc. This occurs when there is a change in the boundary conditions (V, M, etc). When the boundary conditions change, the energy levels change.

For example : particle in a box

$$\varepsilon_j = \frac{\hbar^2 \pi^2}{2m} \frac{1}{V^{2/3}} (n_x^2 + n_y^2 + n_z^2) \quad (4.4)$$

Hence

$$dW = \sum_j n_j d\varepsilon_j \quad (4.5)$$

So, e.g.

$$-P = \sum_j n_j \frac{\partial \varepsilon_j}{\partial V} \quad (4.6)$$

or

$$\mu_0 H = \sum_j n_j \frac{\partial \varepsilon_j}{\partial m} \quad (4.7)$$

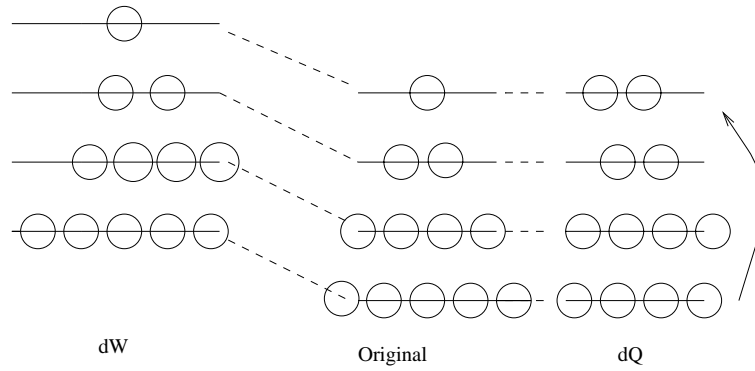

Then $dQ = \sum \varepsilon_j dn_j$ which takes place by rearrangement in the distribution.

In kinetic theory, the particles may collide with the chamber walls and acquire more energy where the walls are hotter (with more heat added).

4.2 Second Law

We now search for a microscopic explanation for S in terms of Ω . We start from the TdS equation :

$$TdS = dU + PdV - \mu dN \tag{4.8}$$

so

$$S \equiv f(E, V, N) \tag{4.9}$$

Also

$$\Omega \equiv g(E, V, N) \tag{4.10}$$

Note : In adiabatic changes, for example, volume increase with no heat added ($dQ = 0$). $dS = 0$ i.e. S is constant. Also $dn_j = 0$ so Ω is also constant.

During irreversible changes, the total S in the Universe increases. The total Ω of the Universe also increases because the equilibrium macrostate must be the maximum Ω .

Now we consider 2 systems with entropy S_1 and S_2 and disorder number Ω_1 and Ω_2 ,

$$\text{Total entropy, } S = S_1 + S_2 \tag{4.11}$$

$$\text{Total } \Omega = \Omega_1 \Omega_2 \tag{4.12}$$

Now

$$S \equiv f(\Omega) \tag{4.13}$$

so $S_1 = f(\Omega_1)$ and $S_2 = f(\Omega_2)$, Now

$$f(\Omega_1 \Omega_2) = f(\Omega_1) + f(\Omega_2) \tag{4.14}$$

Then

$$\frac{\partial f(\Omega_1\Omega_2)}{\partial\Omega_1} = \frac{\partial f(\Omega_1\Omega_2)}{\partial(\Omega_1\Omega_2)}\Omega_2 = \frac{\partial f(\Omega_1)}{\partial\Omega_1} \quad (4.15)$$

So

$$\frac{\partial f(\Omega)}{\partial\Omega}\Omega_2 = \frac{\partial f(\Omega_1)}{\partial\Omega_1} \quad (4.16)$$

Also

$$\frac{\partial f(\Omega_1\Omega_2)}{\partial\Omega_2} = \frac{\partial f(\Omega)}{\partial\Omega}\Omega_1 = \frac{\partial f(\Omega_2)}{\partial\Omega_2} \quad (4.17)$$

Then

$$\frac{1}{\Omega_2} \frac{\partial f(\Omega_1)}{\partial\Omega_1} = \frac{1}{\Omega_1} \frac{\partial f(\Omega_2)}{\partial\Omega_2} \quad (4.18)$$

$$\Omega_1 \frac{\partial f(\Omega_1)}{\partial\Omega_1} = \Omega_2 \frac{\partial f(\Omega_2)}{\partial\Omega_2} = k \quad (4.19)$$

where k is a constant by separation of variables.

So

$$S_1 = f(\Omega_1) = k \ln \Omega_1 + C \quad (4.20)$$

$$S_2 = f(\Omega_2) = k \ln \Omega_2 + C \quad (4.21)$$

$$\begin{aligned} S &= k \ln \Omega_1 + k \ln \Omega_2 + C \\ &= S_1 + S_2 \end{aligned} \quad (4.22)$$

which implies that $C = 0$.

Therefore

$$S = k \ln \Omega \quad (4.23)$$

where k is the Boltzmann constant $\equiv \frac{R}{N_A}$. (To be proven later)

Hence we have a microscopic meaning of entropy. The system is perfectly ordered when $\Omega = 1$ and $S = k \ln \Omega = 0$. When more microstates are available $\Omega > 1$ so $S > 0$. The lesser the knowledge about a system, the more disordered it gets.

From the formula which we obtained for the relation of entropy with Ω , we are unable to deduce the value of k . The value of k comes out from the ideal gas equation.

4.3 Third Law

As the temperature T tends to zero, the contribution to the entropy S from the system components also tend to zero. When all the particles take the ground state, $\Omega(E_0) = 1$. When the macrostate has only one microstate, it implies that there are no further permutations for the Maxwell-Boltzmann distribution.

$$S = k \log \Omega(E_0) = 0$$

Practically, some small interactions (e.g. nuclear paramagnetism) may lift the ground state degeneracy. If $kT > \varepsilon_{int}$, then $S \neq 0$ at a given T . Hence we can only say $S \rightarrow S_0$ as $T \rightarrow 0$ where S_0 is the entropy associated with the remaining small interactions for which $\varepsilon_{int} < kT$ and independent of all the entropy for all the other interactions (degrees of freedom).

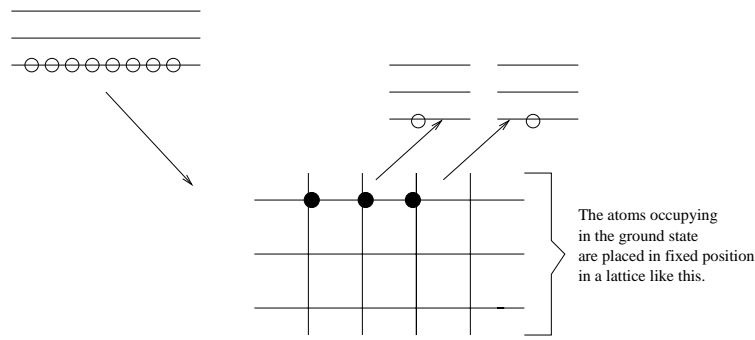

Note that it is meaningless to talk about the exchange of particles in the same state because they do not exchange their positions.

We know from the 2nd law of thermodynamics that heat passes from hot (high temperature) to cold (low temperature) if no work is done. The internal energy $U(T)$ increases when T increases. Now we come to the formulation of the third law :

The **Third Law of Thermodynamics** states that as the temperature $T \rightarrow 0$, the entropy $S \rightarrow 0$, it is approaching ground state as $U(T)$ also approaches 0, \Rightarrow that the disorder number Ω tends to 1.

From the third law, $T=0$ is a theoretically correct statement, but it is an impossibility. Why is this so?

The answer :

There exists very small interactions in the nucleus, made up of magnetic moments, quadrapole moments and octapole moments etc. In order to make $T = 0$, the magnetic moments are required to point in the same direction. However, experimentally, this is not achievable.

The third law of thermodynamics can also be understood in a quantum mechanical

perspective as the freezing out of interactions. By the Schrodinger equation :

$$-\frac{\hbar^2}{2m} \frac{\partial^2 \Psi}{\partial x^2} + V(\Psi) = H \Psi$$

The $V(\Psi)$ consists of many interaction terms. Hence we can approach the total entropy, S as a combination of entropies of many sub-systems :

$$S = S_{\text{total 1}} + S_{\text{total 2}} + S_{\text{total 3}}$$

4.4 Calculation of Other Thermodynamic Variables

From chapter 2, the Partition function Z is defined as :

$$Z = \sum_j g_j e^{-\frac{\epsilon_j}{kT}} \quad (4.24)$$

where j represents all levels.

Now we try to find the relation between P and T , when 2 systems are in thermal equilibrium, where β will be the same. The α depends on the nature of the particles and volume V etc. For the system of same identical particles, free exchange of particles will allow α to reach the same value. Now we proceed to calculate the other thermodynamic variables.

$$\left. \frac{\partial Z}{\partial \beta} \right|_{V,N} = \sum_j -\epsilon_j g_j e^{-\beta \epsilon_j} \quad (4.25)$$

where

$$\beta = \frac{1}{kT}$$

which is proven in tutorial.

We also define the internal energy, U (or E)

$$\begin{aligned} U &= \sum_j n_j \epsilon_j \\ &= \frac{N}{Z} \sum_j g_j e^{-\beta \epsilon_j} \epsilon_j \\ &= -\frac{N}{Z} \frac{\partial Z}{\partial \beta} \Big|_{V,N} \end{aligned} \quad (4.26)$$

Since,

$$\frac{d\beta}{dT} = -\frac{1}{kT^2}$$

and

$$\frac{1}{Z}\partial Z = \partial(\ln Z)$$

therefore,

$$\begin{aligned} U &= -N \frac{\partial \ln Z}{\partial \beta} \Big|_{V,N} \\ &= NkT^2 \frac{\partial \ln Z}{\partial T} \Big|_{V,N} \end{aligned} \quad (4.27)$$

We know that

$$\begin{aligned} n_j &= \frac{N}{Z} g_j e^{-\beta \varepsilon_j} \\ \Rightarrow \frac{g_j}{n_j} &= \frac{Z}{N} e^{\beta \varepsilon_j} \end{aligned}$$

Then we work out $\ln \Omega$,

$$\begin{aligned} \ln \Omega &= N \ln N! + \sum_j (n_j \ln g_j - \ln n_j!) \\ &= N \ln N - N + \sum_j (n_j \ln \left(\frac{g_j}{n_j}\right) + n_j) \\ &= N \ln N + \beta \left(\sum_j n_j \varepsilon_j\right) + N \ln Z - N \ln N \\ &= \beta U + N \ln Z \end{aligned} \quad (4.28)$$

Therefore

$$\begin{aligned} S &= k \ln \Omega \\ &= k\beta U + Nk \ln Z \\ &= \frac{U}{T} + Nk \ln Z \end{aligned} \quad (4.29)$$

The Helmholtz free energy, F is defined as :

$$F = U - TS \quad (4.30)$$

Therefore

$$F = -NkT \ln Z \quad (4.31)$$

Since

$$\begin{aligned} dF &= dU - TdS - SdT \\ &= TdS - PdV - TdS - SdT \\ &= -SdT - PdV \end{aligned} \quad (4.32)$$

From the chain rule

$$dF = \left(\frac{\partial F}{\partial V}\right)_T dV + \left(\frac{\partial F}{\partial T}\right)_V dT$$

Therefore, we can calculate :

Pressure :

$$\begin{aligned} P &= -\left(\frac{\partial F}{\partial V}\right)_T \\ &= NkT \left(\frac{\partial \ln Z}{\partial V}\right)_T \end{aligned} \tag{4.33}$$

Entropy :

$$\begin{aligned} S &= -\left(\frac{\partial F}{\partial T}\right)_V \\ &= Nk \ln Z + \frac{NkT}{Z} \frac{\partial Z}{\partial T} \\ &= Nk \ln Z + \frac{U}{T} \end{aligned} \tag{4.34}$$

Then we can use the results above to compute the heat capacity at constant volume :

$$C_v = \left(\frac{\partial U}{\partial T}\right)_V \tag{4.35}$$

Chapter 5

Applications of Maxwell-Boltzmann Statistics

5.1 Classical Perfect Gas

To apply the Maxwell-Boltzmann Statistics to the classical perfect gas, we require a few conditions :

1. The gas is monatomic, hence we consider only the translational kinetic energy (KE).
2. There is no internal structure for the particles, i.e. no excited electronic states and the particles are treated as single particles.
3. There is no interaction with external fields, e.g. gravity, magnetic fields.
4. The energy is quantized as in the case of particle in a box (in QM).
5. There is a weak mutual interaction - only for exchanging energy between particles and establishing thermal equilibrium, but there is no interference on each other's ε_j .
6. The discrete levels can be replaced by a continuous one if the spacing is small as compared to T , i.e. $\Delta\varepsilon \ll kT$ which is the classical limit.
7. The atoms are pointlike - occupying no volume.

From quantum mechanics,

$$\varepsilon_j = \frac{\hbar^2 \pi^2}{2mL^2} (n_x^2 + n_y^2 + n_z^2)$$

for $V = L^3$ and where n_x , n_y and n_z are integers.

Now we compute the partition function, Z and in this case $g_j = 1$, because all the states are summed over.

$$\begin{aligned}
Z &= \sum_j e^{-\frac{\varepsilon_j}{kT}} \\
&= \sum_{n_x} \sum_{n_y} \sum_{n_z} e^{-\frac{\hbar^2 \pi^2}{2mkTL^2}(n_x^2 + n_y^2 + n_z^2)} \\
&= \sum_{n_x} e^{-\frac{\hbar^2 \pi^2}{2mkTL^2} n_x^2} \sum_{n_y} e^{-\frac{\hbar^2 \pi^2}{2mkTL^2} n_y^2} \sum_{n_z} e^{-\frac{\hbar^2 \pi^2}{2mkTL^2} n_z^2} \\
&= \int_0^\infty dn_x e^{-\frac{\hbar^2 \pi^2}{2mkTL^2} n_x^2} \int_0^\infty dn_y e^{-\frac{\hbar^2 \pi^2}{2mkTL^2} n_y^2} \int_0^\infty dn_z e^{-\frac{\hbar^2 \pi^2}{2mkTL^2} n_z^2}
\end{aligned} \tag{5.1}$$

To evaluate the integral :

$$\text{Let } x = \left(\frac{-\hbar^2 \pi^2}{2mL^2 kT}\right)^{\frac{1}{2}} n_x$$

$$\begin{aligned}
\int_0^\infty e^{-\frac{\hbar^2 \pi^2 n_x^2}{2mL^2 kT}} dn_x &= \left(\frac{2mL^2 kT}{\hbar^2 \pi^2}\right)^{\frac{1}{2}} \frac{1}{2} \int_{-\infty}^\infty e^{-x^2} dx \\
&= L \left(\frac{2mkT}{h^2}\right)^{\frac{1}{2}} \int_{-\infty}^\infty e^{-x^2} dx
\end{aligned} \tag{5.2}$$

where

$$\begin{aligned}
\int_{-\infty}^\infty e^{-x^2} dx &= \left(\int_{-\infty}^\infty e^{-x^2} dx \int_{-\infty}^\infty e^{-y^2} dy\right)^{\frac{1}{2}} \\
&= \left(\int_{-\infty}^\infty \int_{-\infty}^\infty e^{-(x^2+y^2)} dx dy\right)^{\frac{1}{2}} \\
&= \left(\int_0^\infty r dr \int_0^{2\pi} d\theta e^{-r^2}\right)^{\frac{1}{2}} \\
&= \left(\frac{1}{2} 2\pi\right)^{\frac{1}{2}} \\
&= \sqrt{\pi}
\end{aligned} \tag{5.3}$$

Therefore

$$\begin{aligned}
Z &= L^3 \left(\frac{2m\pi kT}{h^2}\right)^{\frac{3}{2}} \\
&= V \left(\frac{2m\pi kT}{h^2}\right)^{\frac{3}{2}}
\end{aligned} \tag{5.4}$$

$$\ln Z = \ln V + \frac{3}{2} \ln T + \frac{3}{2} \ln \frac{2m\pi k}{h^2} \tag{5.5}$$

So,

$$\begin{aligned}
P &= NkT \left(\frac{\partial \ln Z}{\partial V}\right)_T \\
&= \frac{NkT}{V}
\end{aligned} \tag{5.6}$$

$$\text{i.e. } PV = NkT$$

since

$$PV = nRT$$

$$Nk = nR$$

$$k = \frac{n}{N}R$$

$$k = \frac{R}{N_A}$$

(5.7)

because $\frac{N}{n} = N_A$ molecules per mole

$$\begin{aligned} U &= NkT^2 \left(\frac{\partial \ln Z}{\partial T} \right)_V \\ &= NkT^2 \frac{3}{2} \frac{1}{T} \\ &= \frac{3}{2} NkT \end{aligned} \quad (5.8)$$

For each atom,

$$\bar{U} = \frac{3}{2} kT$$

Also the entropy is given by :

$$\begin{aligned} S &= \frac{U}{T} + Nk \ln Z \\ &= \frac{3}{2} Nk + \frac{3}{2} Nk \ln \left(\frac{2m\pi k}{h^2} \right) + Nk (\ln V + \frac{3}{2} \ln T) \end{aligned} \quad (5.9)$$

Therefore, the distribution becomes :

$$\begin{aligned} n_j &= \frac{N}{Z} e^{-\frac{\varepsilon_j}{kT}} \\ &= \frac{Nh^3}{V(2\pi mkT)^{\frac{3}{2}}} e^{-\frac{\varepsilon_j}{kT}} \end{aligned} \quad (5.10)$$

where j represent all n_x , n_y and n_z states.

The number of particles having energies between ε and $\varepsilon + \Delta\varepsilon$:

$$\Delta n = \frac{Nh^3}{V(2\pi mkT)^{\frac{3}{2}}} e^{-\frac{\varepsilon}{kT}} \frac{dn}{d\varepsilon} \Delta\varepsilon \quad (5.11)$$

where $\frac{dn}{d\varepsilon}$ is the density of states, i.e degeneracy $\frac{dn}{d\varepsilon} \Delta\varepsilon$.

To calculate the density of states, we consider the quantum numbers n_x , n_y and n_z making up the grid points with each grid point representing one state.

By writing

$$R^2 = n_x^2 + n_y^2 + n_z^2$$

The number of points (states) with energy up to ε_R lie within a sphere of volume $\frac{4}{3}\pi R^3$. Only positive n's are allowed so we take the positive octant.

The number of states lying between energy ε and $\varepsilon + \Delta\varepsilon$ will become :

$$\begin{aligned} \frac{dn}{d\varepsilon} \Delta\varepsilon &= \frac{1}{8}(4\pi R^2) \Delta R \\ &= \frac{1}{8}(4\pi R^2) \frac{dR}{d\varepsilon} \Delta\varepsilon \end{aligned} \quad (5.12)$$

Using

$$\varepsilon = \frac{\hbar^2 \pi^2}{2mL^2} R^2$$

we obtain,

$$\frac{d\varepsilon}{dR} = \frac{\hbar^2 \pi^2}{mL^2} R$$

Therefore,

$$\begin{aligned} \frac{dn}{d\varepsilon} \Delta\varepsilon &= \frac{\pi}{2} R \frac{mL^2}{\hbar^2 \pi^2} \Delta\varepsilon \\ &= \frac{\pi}{4} \frac{(2m)^{\frac{3}{2}} L^3}{\hbar^3 \pi^3} \varepsilon^{\frac{1}{2}} \Delta\varepsilon \\ &= 2\pi V \frac{(2m)^{\frac{3}{2}}}{h^3} \varepsilon^{\frac{1}{2}} \Delta\varepsilon \end{aligned} \quad (5.13)$$

Therefore,

$$\begin{aligned} \Delta n &= \frac{VN h^3 e^{-\frac{\varepsilon}{kT}}}{(2\pi mkT)^{\frac{3}{2}}} 2\pi v \frac{(2m)^{\frac{3}{2}}}{h^3} \varepsilon^{\frac{1}{2}} \Delta\varepsilon \\ &= \frac{N \varepsilon^{\frac{1}{2}} e^{-\frac{\varepsilon}{kT}}}{\sqrt{\frac{\pi}{4}} (kT)^{\frac{3}{2}}} \Delta\varepsilon \end{aligned} \quad (5.14)$$

For the momentum distribution, we use :

$$\varepsilon = \frac{p^2}{2m}$$

and

$$\frac{d\varepsilon}{dp} = \frac{p}{m}$$

So, the number of particles have momentum between p and $p + \Delta p$ is :

$$\begin{aligned}\Delta n &= \frac{N}{\sqrt{\frac{\pi}{4}}(kT)^{\frac{3}{2}}} \frac{p}{\sqrt{2m}} e^{-\frac{p^2}{2mkT}} \frac{d\varepsilon}{dp} \Delta p \\ &= \frac{N}{(2\pi mkT)^{\frac{3}{2}}} 4\pi e^{-\frac{p^2}{2mkT}} p^2 \Delta p\end{aligned}\quad (5.15)$$

Note that

$$\begin{aligned}\iiint_{\text{all } p \text{ space}} dp_x dp_y dp_z &= \int_0^{2\pi} d\phi_p \int_0^\pi \sin \theta_p d\theta_p \int_0^\infty p^2 dp \\ &= \int_0^\infty 4\pi p^2 dp\end{aligned}\quad (5.16)$$

Therefore we can also express in p_x , p_y and p_z as

$$\begin{aligned}\Delta n &= \frac{N}{(2\pi mkT)^{\frac{3}{2}}} e^{-\frac{p^2}{2mkT}} \Delta p_x \Delta p_y \Delta p_z \\ &= \frac{N}{(2\pi mkT)^{\frac{3}{2}}} e^{-\frac{p_x^2 + p_y^2 + p_z^2}{2mkT}} \Delta p_x \Delta p_y \Delta p_z \\ &= \frac{N}{(2\pi mkT)^{\frac{3}{2}}} e^{-\frac{p_x^2}{2mkT}} \Delta p_x e^{-\frac{p_y^2}{2mkT}} \Delta p_y e^{-\frac{p_z^2}{2mkT}} \Delta p_z\end{aligned}\quad (5.17)$$

For velocity distribution, we use $p = mv$,

$$\begin{aligned}\Delta n &= f(v_x, v_y, v_z) dv_x dv_y dv_z \\ &= \frac{Nm^3}{(2\pi mkT)^{\frac{3}{2}}} e^{-\frac{m(v_x^2 + v_y^2 + v_z^2)}{2kT}} \Delta v_x \Delta v_y \Delta v_z \\ &= g(v) dv \\ &= \frac{Nm^3 4\pi}{(2\pi mkT)^{\frac{3}{2}}} e^{-\frac{m(v^2)}{2kT}} v^2 dv\end{aligned}\quad (5.18)$$

which are the Maxwell distribution laws for velocities and speeds.

We invoke a few integral identities :

$$\begin{aligned}I_n &= \int_0^\infty e^{-x^2} x^n dx \\ I_0 &= \frac{\sqrt{\pi}}{2} \\ I_1 &= \frac{1}{2} \\ I_2 &= \frac{1}{2} I_0 \\ I_3 &= I_1 \\ I_4 &= \frac{3}{2} I_2\end{aligned}$$

So,

$$\begin{aligned} \int_0^\infty g(v)dv &= \frac{Nm^3 4\pi}{(2\pi mkT)^{\frac{3}{2}}} \left(\frac{2kT}{m}\right)^{\frac{3}{2}} \int_0^\infty e^{-x^2} x^2 dx \\ &= N \end{aligned} \quad (5.19)$$

The mean speed, \bar{v}

$$\begin{aligned} \bar{v} &= \frac{1}{N} \int_0^\infty v g(v) dv \\ &= \frac{m^3 4\pi}{(2\pi mkT)^{\frac{3}{2}}} \left(\frac{2kT}{m}\right)^2 \int_0^\infty e^{-x^2} x^3 dx \\ &= \sqrt{\frac{8kT}{\pi m}} \end{aligned} \quad (5.20)$$

and mean square speed is

$$\begin{aligned} \bar{v}^2 &= \frac{1}{N} \int_0^\infty v^2 g(v) dv \\ &= \frac{m^3 4\pi}{(2\pi mkT)^{\frac{5}{2}}} \int_0^\infty e^{-x^2} x^4 dx \\ &= \frac{3kT}{m} \end{aligned} \quad (5.21)$$

$$\text{Average energy, } \frac{1}{2} m \bar{v}^2 = \frac{3}{2} kT \quad (5.22)$$

$$\text{Root mean square (RMS) speed, } \sqrt{\bar{v}^2} = \sqrt{\frac{3kT}{m}} > \bar{v} \quad (5.23)$$

The most probable speed :

$$\begin{aligned} \frac{dg(v)}{dv} = 0 &\Rightarrow 2v_p e^{-\frac{mv_p^2}{2kT}} - \frac{mv_p^3}{kT} e^{-\frac{mv_p^2}{2kT}} = 0 \\ &\Rightarrow v_p = \sqrt{\frac{2kT}{m}} \end{aligned} \quad (5.24)$$

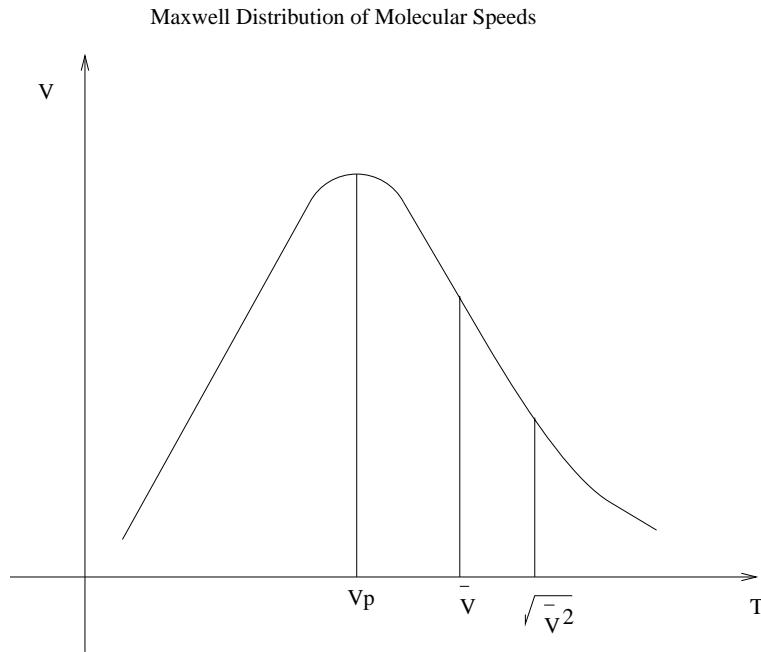

$$v_p < \bar{v} < \sqrt{\bar{v}^2}$$

5.2 Harmonic Oscillator

We now consider the simple 1-D harmonic oscillator in equilibrium at T , with the

$$\text{Hamiltonian, } H = \frac{p^2}{2m} + \frac{1}{2}k_0x^2$$

$$\varepsilon_j = \left(j + \frac{1}{2}\right)\hbar\omega$$

where $j = 0, 1, 2, \dots$

$$\omega = \sqrt{\frac{k_0}{m}}$$

Assume the oscillators are independent and distinguishable,

$$n_j = \frac{N}{Z} e^{-\frac{\varepsilon_j}{kT}}$$

$$\begin{aligned}
 Z &= \sum_{j=0}^{\infty} e^{-\frac{(j+\frac{1}{2})\hbar\omega}{kT}} \\
 &= e^{-\frac{\hbar\omega}{2kT}} \sum_{j=0}^{\infty} e^{-\frac{j\hbar\omega}{kT}} \\
 &= e^{-\frac{\hbar\omega}{2kT}} \frac{1}{1 - e^{-\frac{\hbar\omega}{kT}}} \\
 &= e^{-\frac{\beta\hbar\omega}{2}} \frac{1}{1 - e^{-\beta\hbar\omega}}
 \end{aligned} \tag{5.25}$$

Note : for a series of a, ar, ar^2, \dots

$$\sum_{n=0}^{\infty} ar^n = \frac{a}{1-r}$$

$$\ln Z = -\frac{1}{2}\beta\hbar\omega - \ln(1 - e^{-\beta\hbar\omega}) \quad (5.26)$$

$$\begin{aligned} U &= -N \frac{\partial \ln Z}{\partial \beta} \\ &= \frac{1}{2}N\hbar\omega + \frac{N}{1 - e^{-\beta\hbar\omega}} \hbar\omega e^{-\beta\hbar\omega} \\ &= N\hbar\omega \left[\frac{1}{2} + \frac{1}{e^{\beta\hbar\omega} - 1} \right] \\ &= N\hbar\omega \left[\frac{1}{2} + \frac{1}{e^{\frac{\hbar\omega}{kT}} - 1} \right] \end{aligned} \quad (5.27)$$

At low T, $U \approx \frac{1}{2}N\hbar\omega$, it means that the oscillators are in ground state.

At high T,

$$\begin{aligned} U &= N\hbar\omega \left[\frac{1}{2} + \frac{1}{1 + \frac{\hbar\omega}{kT} + \dots - 1} \right] \\ &= N\hbar\omega \left[\frac{1}{2} + \frac{kT}{\hbar\omega} \right] \\ &= NkT \end{aligned} \quad (5.28)$$

which is the classical result.

The high energy states are occupied. Quantization is not important for $kT \gg \Delta\varepsilon (= \hbar\omega)$

5.3 Equipartition Theorem

The **Equipartition theorem** states that all terms in the Hamiltonian with squared coordinates (x or p_x etc) will contribute $\approx \frac{1}{2}kT$ to the average energy, provided quantization is not important. This is reflected in the classical regime at high T (where $kT \gg \Delta\varepsilon_{int}$).

Example 1 : Ideal Gas,

$$\begin{aligned} H &= \text{kinetic energy only} \\ &= \frac{p_x^2}{2m} + \frac{p_y^2}{2m} + \frac{p_z^2}{2m} \end{aligned}$$

Therefore

$$\begin{aligned} U &= \frac{3}{2}kT \times N \text{ atoms} \\ &= \frac{3}{2}NkT \end{aligned}$$

Example 2 : 1-D Harmonic Oscillator,

$$\begin{aligned} H &= \text{Kinetic energy} + \text{Potential energy} \\ &= \frac{p_x^2}{2m} + \frac{1}{2}k_0x^2 \end{aligned}$$

Therefore

$$\begin{aligned} U &= kT \times N \text{ atoms} \\ &= NkT \end{aligned}$$

With quantization setting in at low T, the Hamiltonian is frozen out and the contribution is not $\frac{1}{2}kT$.

Example 3 : Diatomic gas,

For translational motion,

$$H_{trans} = \frac{p_x^2}{2m} + \frac{p_y^2}{2m} + \frac{p_z^2}{2m}$$

For rotational motion,

$$H_{rot} = \frac{1}{2} \frac{L_x^2}{I_x} + \frac{1}{2} \frac{L_y^2}{I_y}$$

neglecting rotation about z-axis.

For vibrational motion,

$$H_{vib} = \frac{p_z'^2}{2m} + \frac{1}{2}k_0z'^2$$

where z' is the relative coordinate between the 2 atoms.

Therefore, the total internal energy, U should be $\frac{7}{2}NkT$. However, the experimental results show that $U = \frac{5}{2} NkT$.

The reason is because the vibrational motion is frozen out, i.e. $\hbar\omega_{vib} \gg kT$. So in terms of H_{vib} , the atoms are in ground state, i.e. atoms don't appear to vibrate much at normal temperature.

$$\text{Total } H = H_{vib} + H_{trans} + H_{rot} \quad (5.29)$$

Chapter 6

Paramagnetic Systems

6.1 Introduction

For a paramagnetic spin system, the atoms have unpaired electrons or partially filled orbitals. The net angular momentum \vec{J} for each atom is equal to both the linear orbital angular momentum, \vec{L} and spin, \vec{S} . It also acts like the magnetic moment.

$$\mu_J = -g_J \mu_B \vec{J} \quad (6.1)$$

When the system interacts with an external magnetic field,

$$\begin{aligned} \text{Hamiltonian, } H &= -\vec{\mu} \cdot \vec{B} \\ &= g_J \mu_B \vec{B} \cdot \vec{J} \\ &= g_J \mu_B B_z J_z \text{ (Quantization)} \end{aligned} \quad (6.2)$$

The J_z and J are observed from atomic physics.

$$\mu_B = \frac{e\hbar}{2mc} \text{ (Bohr Magnetron)}$$

In a solid, the outer electrons are involved in valency for chemical bonds, which are ultimately paired up so that the net J of outer electrons is zero. The inner core, particularly 3d, 4d and 4f orbitals of many elements are not involved in valency, so magnetism arises from their S, L and J.

In many solids of transition elements (3d), the orbital quenching occurs, so that the net $L = 0$ for atoms in the ground electronic state. Note that the excited electronic states are unoccupied at room temperature because $\Delta\varepsilon \gg kT$.

Hence in the ground electronic state of 3d elements, there is a degeneracy of $(2S + 1)$ states. Note that $J = S$.

Applying B-field to a spin $\frac{3}{2}$ system :

For example,

S = 3/2 system

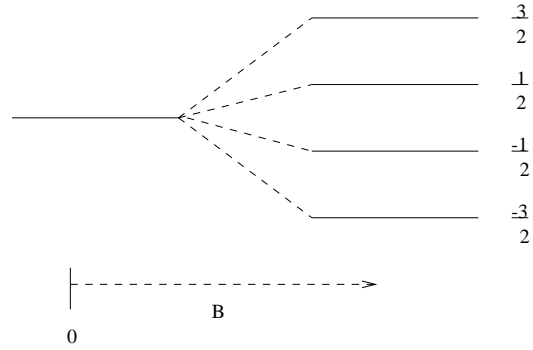

$$\text{Hamiltonian, } H = g_s \mu_B B S_z \quad (6.3)$$

and $g_s \approx 2$ for electron spin.

The distribution in the spin states is associated with the spin temperature T_S which may not be the same as the lattice temperature T_L . A mechanism must exist for T_S and T_L to establish thermal equilibrium - spin-phonon interaction. This is important in spin resonance experiments such as electron spin resonance and nuclear magnetic resonance, and determines the relaxation time τ .

6.2 Spin $\frac{1}{2}$ Quantum System

We consider the system of N magnetic atoms of spin $\frac{1}{2}$ due to 1 unpaired electron.

$$\begin{aligned} \text{The magnetic moment, } \mu &= -g_s \mu_B S_z \\ &= \mp \frac{1}{2} g_s \mu_B \end{aligned} \quad (6.4)$$

The Zeeman interaction with external field gives energy levels

$$g_s \mu_B B_z S_z = \pm \frac{1}{2} g_s \mu_B B \quad (6.5)$$

where $g_s \approx 2$ and μ_B is the Bohr magneton.

The \pm energies correspond to spin \downarrow (μ antiparallel to B) or spin \uparrow (μ parallel to B).

So

$$\varepsilon_{\uparrow} = -\frac{1}{2}g_s\mu_B B \quad (6.6)$$

$$\varepsilon_{\downarrow} = +\frac{1}{2}g_s\mu_B B \quad (6.7)$$

Using the Maxwell-Boltzmann distribution,

$$n_{\uparrow} = \frac{N}{Z} e^{+\frac{g_s\mu_B B}{2kT}} \quad (6.8)$$

$$n_{\downarrow} = \frac{N}{Z} e^{-\frac{g_s\mu_B B}{2kT}} \quad (6.9)$$

where

$$\begin{aligned} Z &= e^{+\frac{g_s\mu_B B}{2kT}} + e^{-\frac{g_s\mu_B B}{2kT}} \\ &= 2 \cosh\left(\frac{g_s\mu_B B}{2kT}\right) \end{aligned} \quad (6.10)$$

Therefore, the total energy, E :

$$\begin{aligned} E &= \frac{N}{Z} \left(-\frac{1}{2}g_s\mu_B B e^{+\frac{g_s\mu_B B}{2kT}} + \frac{1}{2}g_s\mu_B B e^{-\frac{g_s\mu_B B}{2kT}} \right) \\ &= -\frac{N g_s\mu_B B}{Z} \left(\sinh\left(\frac{g_s\mu_B B}{2kT}\right) \right) \\ &= -\frac{N g_s\mu_B B}{Z} \left(\tanh\left(\frac{g_s\mu_B B}{2kT}\right) \right) \end{aligned} \quad (6.11)$$

The entropy S :

$$\begin{aligned} S &= \frac{U}{T} + Nk \ln Z \\ &= -\frac{N g_s\mu_B B}{T} \left(\tanh\left(\frac{g_s\mu_B B}{2kT}\right) \right) + Nk \ln\left(2 \cosh\left(\frac{g_s\mu_B B}{2kT}\right)\right) \end{aligned} \quad (6.12)$$

The magnetization M :

$$\begin{aligned} M &= \frac{1}{V} \sum_j n_j \mu_j \\ &= \frac{N}{VZ} \sum \mu_j e^{+\frac{\mu_j B}{kT}} \\ &= \frac{N}{VZ} \left[\frac{1}{2}g_s\mu_B e^{\frac{g_s\mu_B B}{2kT}} - \frac{1}{2}g_s\mu_B e^{-\frac{g_s\mu_B B}{2kT}} \right] \\ &= \frac{N}{VZ} g_s\mu_B \sinh\left(\frac{g_s\mu_B B}{2kT}\right) \\ &= \frac{1}{2} \frac{N}{V} g_s\mu_B \tanh\left(\frac{g_s\mu_B B}{2kT}\right) \\ &= -\frac{E}{BV} \end{aligned} \quad (6.13)$$

where $\varepsilon = \mu B$

6.3 Spin J Quantum System

Now we consider a system with total angular momentum J in an external B-field.

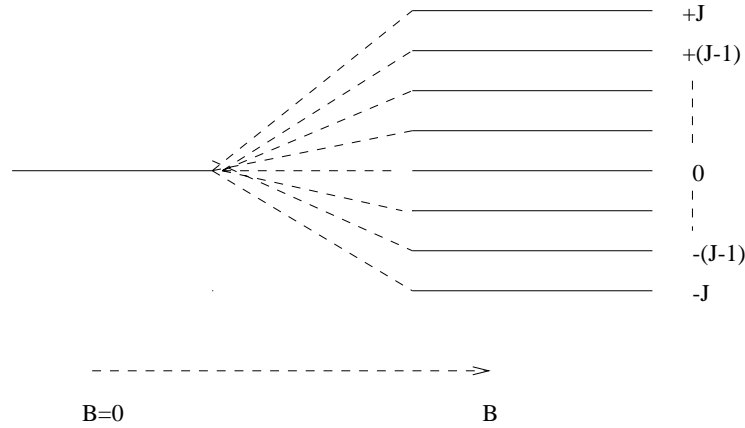

$$m_J = -J, -(J - 1), \dots, 0, 1, \dots, (J - 1), J$$

Therefore there are $(2J + 1)$ states.

$$\epsilon_J = g_J \mu_B B m_J \tag{6.14}$$

where g_J is the Lande g-factor (an experimental quantity).

Let

$$y = g_J \mu_B B \beta$$

Therefore, the partition function,

$$\begin{aligned} Z &= \sum_{m_J=-J}^J e^{g_J \mu_B B \beta m_J} \\ &= \sum_{m_J=-J}^J e^{y m_J} \\ &= e^{-yJ} \sum_{m_J=0}^{2J} e^{y m_J} \\ &= (e^{-yJ}) \frac{e^{(2J+1)y} - 1}{e^y - 1} \tag{G.P sum = \frac{a(r^n - 1)}{r - 1}} \\ &= \frac{e^{(J+1)y} - e^{-Jy}}{e^y - 1} \\ &= \frac{e^{(J+\frac{1}{2})y} - e^{-(J+\frac{1}{2})y}}{e^{\frac{1}{2}y} - e^{-\frac{1}{2}y}} \\ &= \frac{\sinh(J + \frac{1}{2})y}{\sinh \frac{y}{2}} \end{aligned} \tag{6.15}$$

Therefore,

$$\begin{aligned} n_J &= \frac{N}{Z} e^{-\beta \varepsilon_J} \\ &= \frac{N}{Z} e^{-\beta g_J \mu_B B m_J} \end{aligned} \quad (6.16)$$

Then

$$\begin{aligned} \text{Magnetization, } M &= \frac{N}{VZ} \sum g_J \mu_B m_J e^{\beta g_J \mu_B B m_J} \\ &= \frac{N}{VZ} \frac{1}{\beta} \frac{\partial Z}{\partial B} \\ &= \frac{N}{VZ} \frac{1}{\beta} \frac{\partial Z}{\partial y} \frac{\partial y}{\partial B} \\ &= \frac{N}{VZ} g_J \mu_B \frac{\partial Z}{\partial y} \\ &= \frac{N}{V} g_J \mu_B \frac{\partial \ln Z}{\partial y} \end{aligned} \quad (6.17)$$

$$\ln Z = \ln(\sinh(J + \frac{1}{2})y) - \ln(\sinh \frac{y}{2}) \quad (6.18)$$

$$\begin{aligned} M &= \frac{N}{V} g_J \mu_B \left(\frac{(J + \frac{1}{2}) \cosh(J + \frac{1}{2})y}{\sinh(J + \frac{1}{2})y} - \frac{\frac{1}{2} \cosh \frac{y}{2}}{\sinh \frac{y}{2}} \right) \\ &= \frac{N}{V} g_J \mu_B \left((J + \frac{1}{2}) \coth(J + \frac{1}{2})y - \frac{1}{2} \coth \frac{y}{2} \right) \\ &= \frac{N}{V} g_J \mu_B J B_J(y) \end{aligned} \quad (6.19)$$

where

$$B_J(y) = \frac{1}{J} \left[(J + \frac{1}{2}) \coth(J + \frac{1}{2})y - \frac{1}{2} \coth \frac{y}{2} \right] \quad \text{Brillouin function} \quad (6.20)$$

We proceed to evaluate other thermodynamic quantities :

$$\begin{aligned} \text{Helmholtz free energy, } F &= -NkT \ln Z \\ &= -NkT \left[\ln(\sinh(J + \frac{1}{2})y) - \ln(\sinh \frac{y}{2}) \right] \end{aligned} \quad (6.21)$$

$$\begin{aligned} \text{Internal energy, } U &= -N \frac{\partial \ln Z}{\partial \beta} \\ &= -N \frac{\partial \ln Z}{\partial y} \frac{\partial y}{\partial \beta} \\ &= -N g_J \mu_B B J B_J(y) \end{aligned} \quad (6.22)$$

$$\begin{aligned}
\text{Entropy, } S &= \frac{U}{T} + NK \ln Z \\
&= -\frac{N g_J \mu_B B J B_J(y)}{T} + Nk \left[\ln \left(\sinh \left(J + \frac{1}{2} \right) y \right) - \ln \left(\sinh \frac{y}{2} \right) \right]
\end{aligned} \tag{6.23}$$

At high T, $y \ll 1$, and for small x ,

$$\begin{aligned}
\coth x &= \frac{e^x + e^{-x}}{e^x - e^{-x}} \\
&= \frac{e^{2x} + 1}{e^{2x} - 1} \\
&= \left(1 + 2x + \frac{4x^2}{2} + \dots + 1 \right) \left(1 + 2x + \frac{4x^2}{2} + \frac{8x^3}{3!} + \dots - 1 \right)^{-1} \\
&= \frac{1}{2x} (2 + 2x + 2x^2 + \dots) \left(1 + x + \frac{2x^2}{3} + \dots \right) \\
&= \frac{1}{x} (1 + x + x^2 + \dots) \left(1 - \left(x + \frac{2x^2}{3} + \dots \right) + \left(x + \frac{2x^2}{3} + \dots \right)^2 + \dots \right) \\
&= \frac{1}{x} (1 + x - x + x^2 - x^2 - \frac{x^2}{3} + 2\dots) \\
&= \frac{1}{x} \left(1 + \frac{x^2}{3} + \dots \right) \\
&= \frac{1}{x} + \frac{x}{3}
\end{aligned} \tag{6.24}$$

So,

$$\begin{aligned}
B_J(y) &= \frac{1}{J} \left[\left(J + \frac{1}{2} \right) \left(\frac{1}{\left(J + \frac{1}{2} \right) y} + \frac{\left(J + \frac{1}{2} \right) y}{3} \right) - \frac{1}{2} \left(\frac{1}{\frac{y}{2}} + \frac{\frac{y}{2}}{3} \right) \right] \\
&= \frac{1}{J} \left[\frac{1}{y} + \frac{\left(J + \frac{1}{2} \right)^2 y}{3} - \frac{1}{y} - \frac{y}{12} \right] \\
&= \frac{1}{3J} [(J^2 + J)y] \\
&= \frac{y}{3} (J + 1)
\end{aligned} \tag{6.25}$$

Therefore,

$$\begin{aligned}
M &= \frac{N}{V} g_J \mu_B J (J + 1) \frac{y}{3} \\
&= \frac{N g_J^2 \mu_B^2 J (J + 1) B}{V 3kT}
\end{aligned} \tag{6.26}$$

so,

$$\begin{aligned}
\chi &= \mu_0 \left(\frac{\partial \mu}{\partial B} \right)_T \\
&= \frac{N g_J^2 \mu_B^2 \mu_0 J (J + 1)}{V 3kT} \\
&\propto \frac{1}{T} \quad (\text{Curie's law})
\end{aligned} \tag{6.27}$$

Since,

$$U = -\frac{Ng_J\mu_B B J(J+1)y}{3} \rightarrow 0$$

Since,

$$\ln Z \approx \ln(2J+1) \quad (6.28)$$

Proof :

$$\begin{aligned} \ln Z &= \ln \frac{e^{(J+\frac{1}{2})y} - e^{-(J+\frac{1}{2})y}}{2} \\ &= \ln \left[e^{-(J+\frac{1}{2})y} \frac{e^{-(J+\frac{1}{2})2y} - 1}{2} - \ln \left[e^{\frac{-y}{2}} \frac{e^y - 1}{2} \right] \right] \\ &= -(J + \frac{1}{2})y + \ln \left(\frac{1 + (J + \frac{1}{2})2y + \dots - 1}{2} \right) + \frac{y}{2} - \ln \left(\frac{1 + y + \dots - 1}{2} \right) \quad (6.29) \\ &= -Jy + \ln \left[(J + \frac{1}{2})y + \dots \right] - \ln \left[\frac{y}{2} + \dots \right] \\ &= -Jy + \ln(2J+1) \\ &\approx \ln(2J+1) \end{aligned}$$

or

$$\begin{aligned} \ln Z &= \ln \left[\frac{(1 + (J + \frac{1}{2})y + \dots) - (1 - (J + \frac{1}{2} + \dots))}{2} \right] - \ln \left[\frac{(1 + \frac{y}{2} + \dots) - (1 - \frac{y}{2} + \dots)}{2} \right] \\ &= \ln \left(J + \frac{1}{2} \right) y - \ln \frac{y}{2} \\ &= \ln(2J+1) \end{aligned} \quad (6.30)$$

Then

$$S = Nk \ln(2J+1) \quad (6.31)$$

for $(2J+1)$ levels.

At low T, $y \gg 1$, and for large x,

$$\coth x = \frac{e^x + e^{-x}}{e^x - e^{-x}} = 1$$

So,

$$B_J(y) = \frac{1}{J} \left[J + \frac{1}{2} - \frac{1}{2} \right] = 1 \quad (6.32)$$

Therefore

$$M = \frac{N}{V} g_J \mu_B J \quad (6.33)$$

where all spins are align in the same direction (parallel to B), hence $\chi \rightarrow 0$.

$$\begin{aligned} \ln Z &= \ln\left(\frac{e^{(J+\frac{1}{2})y} - e^{-(J+\frac{1}{2})y}}{2}\right) - \ln\left(\frac{e^{\frac{y}{2}} - e^{-\frac{y}{2}}}{2}\right) \\ &= \left(J + \frac{1}{2}\right)y + \ln \frac{1}{2} - \frac{y}{2} - \ln \frac{1}{2} \\ &= Jy \end{aligned} \tag{6.34}$$

$$\text{Internal energy, } U = -Ng_J\mu_B B J \tag{6.35}$$

$$\text{Entropy, } S = \frac{-Ng_J\mu_B B J}{T} + Nk J y = 0 \tag{6.36}$$

6.4 Adiabatic Cooling

From the third law, $S \rightarrow 0$ as $T \rightarrow 0$, so cooling reduces the entropy of system, so we need magnetic dipoles to align in one direction.

But alignment can also be produced with a B-field, so we need the alignment to stay as we reduce the B-field to zero.

So adiabatic cooling is two-staged.

1. Reduce the entropy by turning on the B-field isothermally.

The paramagnetic system is in contact with the lattice and the heat bath. As B-field increases, dipoles align more and energy and entropy is taken out from the system.

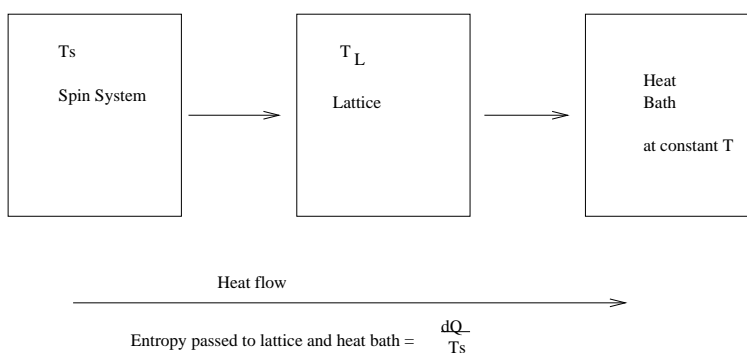

2. Reduce the temperature by turning off the B-field adiabatically, i.e. isolated from heat bath.

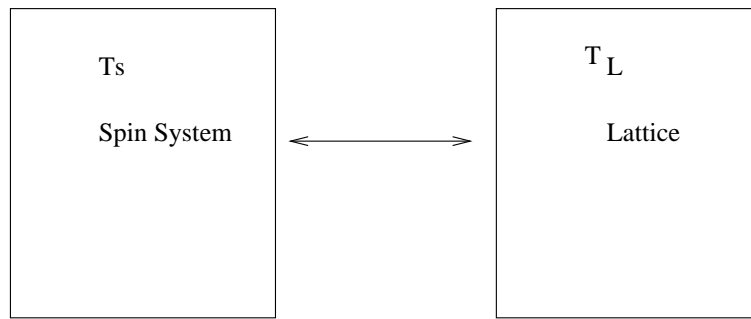

Remove the B-field adiabatically to keep spins align.

As B decreases, S_{spin} stays constant, so T_S decreases. The lattice passes heat and entropy back to spin. But this entropy is so small because of low T_L , S_{Lat} is small, so the heat passing is very small. ($dQ = TdS$). Hence both T_S and T_L will drop drastically.

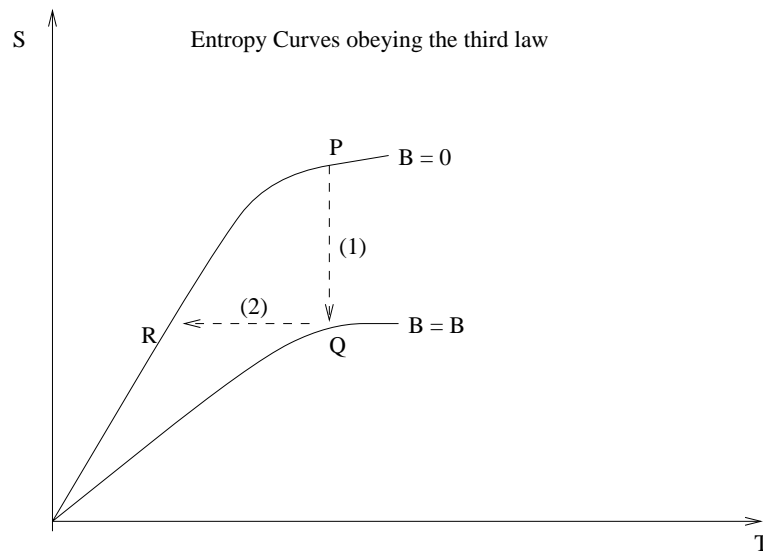

Note : They obey the 3rd law
 Stage (1) : From P to Q, Isothermal Magnetization
 Stage (2) : From Q to R, Adiabatic Demagnetization

Chapter 7

Applications of Fermi-Dirac Statistics

7.1 Fermi-Dirac Distribution

From chapter 3, we obtain two quantum distributions :

1. Fermi-Dirac Distribution

$$n_j = \frac{g_j}{e^{-\alpha} e^{\beta \varepsilon} + 1} \quad (7.1)$$

2. Bose-Einstein Distribution

$$n_j = \frac{g_j}{e^{-\alpha} e^{\beta \varepsilon} - 1} \quad (7.2)$$

For either systems, $\beta = \frac{1}{kT}$. This can be proven by having the quantum system in contact with a classical perfect gas where $\beta = \frac{1}{kT}$. The two β s will reach equilibrium at same temperature.

Now to identify α for Fermi-Dirac distribution, we consider 2 fermion systems in thermal and diffusive contact so to allow particle exchange. We also assume that the same type of fermions for both systems.

With the same constraints :

$$\begin{aligned} \sum n_i + \sum n_j &= N \\ \sum n_i \varepsilon_i + \sum n_j \varepsilon_j &= E \end{aligned}$$

$$\begin{aligned} \Omega &= \Omega_i \Omega_j \\ &= \prod_i \frac{g_i}{n_i! (g_i - n_i)!} \prod_j \frac{g_j}{n_j! (g_j - n_j)!} \end{aligned} \quad (7.3)$$

$$\begin{aligned}
\ln \Omega &= \sum_i g_i \ln g_i - g_i - (g_i - n_i) \ln(g_i - n_i) + (g_i - n_i) - n_i \ln n_i + n_i \\
&+ \sum_j g_j \ln g_j - g_j - (g_j - n_j) \ln(g_j - n_j) + (g_j - n_j) - n_j \ln n_j + n_j \\
&= \sum_i g_i \ln g_i - (g_i - n_i) \ln(g_i - n_i) - n_i \ln n_i + \sum_j g_j \ln g_j - (g_j - n_j) \ln(g_j - n_j) - n_j \ln n_j
\end{aligned} \tag{7.4}$$

$$\begin{aligned}
d \ln \Omega &= \sum_i \ln(g_i - n_i) dn_i + dn_i - \ln n_i dn_i - dn_i + \sum_j \ln(g_j - n_j) dn_j + dn_j - \ln n_j dn_j - dn_j \\
&= \sum_i \left(\ln \frac{g_i - n_i}{n_i} \right) dn_i + \sum_j \left(\ln \frac{g_j - n_j}{n_j} \right) dn_j \\
&= 0
\end{aligned} \tag{7.5}$$

Using the method of Lagrange multipliers,

$$\begin{aligned}
\alpha \left(\sum_i dn_i + \sum_j dn_j \right) &= 0 \\
-\beta \left(\sum_i \varepsilon_i dn_i + \sum_j \varepsilon_j dn_j \right) &= 0
\end{aligned}$$

So,

$$\sum_i \left(\ln \frac{g_i - n_i}{n_i} - \alpha + \beta \varepsilon_i \right) dn_i + \sum_j \left(\ln \frac{g_j - n_j}{n_j} - \alpha + \beta \varepsilon_j \right) dn_j = 0 \tag{7.6}$$

Then Choose α and β , so that

$$\begin{aligned}
\ln \frac{g_i - n_i}{n_i} - \alpha + \beta \varepsilon_i &= 0 \\
\ln \frac{g_j - n_j}{n_j} - \alpha + \beta \varepsilon_j &= 0
\end{aligned}$$

Then

$$\begin{aligned}
n_i &= \frac{g_i}{e^{-\alpha} e^{\beta \varepsilon_i} + 1} \\
n_j &= \frac{g_j}{e^{-\alpha} e^{\beta \varepsilon_j} + 1}
\end{aligned}$$

So the two systems in thermal contact have the same β and the two systems in diffusive contact will have the same α , which is related to μ .

The diffusive contact gives rise to chemical equilibrium, so

$$\mu_i = \mu_j = \mu \quad (\text{chemical potential})$$

Suppose we take one of the systems :

$$\begin{aligned}
S_j &= k \ln \Omega_j \\
&= \sum_j g_j \ln g_j - (g_j - n_j) \ln(g_j - n_j) - n_j \ln n_j
\end{aligned} \tag{7.7}$$

Then

$$\begin{aligned}
 dS &= k \sum_j \ln(g_j - n_j) dn_j + dn_j - n_j \ln n_j - dn_j \\
 &= k \sum_j \ln \frac{g_j - n_j}{n_j} dn_j \\
 &= k \sum_j (-\alpha + \beta \varepsilon_j) dn_j \tag{7.8} \\
 &= -k\alpha \sum_j dn_j + k\beta \sum_j [d(n_j \varepsilon_j) - n_j d\varepsilon_j] \\
 &= -k\alpha dN + k\beta dU - k\beta dW
 \end{aligned}$$

$$\begin{aligned}
 TdS &= -kT\alpha dN + dU - dW \\
 &= -\mu dN + dU - dW \tag{7.9}
 \end{aligned}$$

because

$$dU = TdS + dW + \mu dN$$

Therefore

$$\alpha = \frac{\mu}{kT} \quad (\text{same derivation for bosons}) \tag{7.10}$$

So

$$n_j = \frac{g_j}{e^{\frac{\varepsilon_j - \mu}{kT}} + 1} \tag{7.11}$$

where μdN is the work done in moving the fermions from one place to another, e.g electrical work.

7.2 Free Electron Model of Metals

The valence electrons (in the outermost shell) are loosely bound, i.e. takes little energy to detach them, hence they have low ionisation potential.

In metal, the weakly attached conducting electrons are “free” to move in the lattice. The electrons interact with the electrostatic potential of the positive ions in the lattice. If we consider the periodicity of the potential, we will obtain the solution to the Schrodinger equation in the form of Bloch waves. The energy will form a band.

For perfect stationary lattice, there is free propagation and infinite conductivity of electrons. However lattice imperfections, lattice vibrations (phonons) and the scattering by the other electrons leads to resistance in the lattice.

In the free electron model, we apply Fermi-Dirac Statistics - electrons of spin $\pm\frac{1}{2}$ and $\sigma = \pm\frac{1}{2}$. We neglect the lattice potential, the electrons are confined in a box (body of

metal) and we neglect the mutual interactions (electron-electron scattering).

For single particle state (n_x, n_y, n_z, σ) , the energy is given by :

$$\begin{aligned}\varepsilon_{n_x, n_y, n_z, \sigma} &= \frac{\hbar^2 \pi^2}{2mL^2} (n_x^2 + n_y^2 + n_z^2) \\ &= \frac{\hbar^2}{2m} k^2\end{aligned}\quad (7.12)$$

where k is the wavevector $\frac{2\pi}{\lambda}$ and is defined by the following relation :

$$k^2 = \frac{\pi^2}{L^2} (n_x^2 + n_y^2 + n_z^2) \quad (7.13)$$

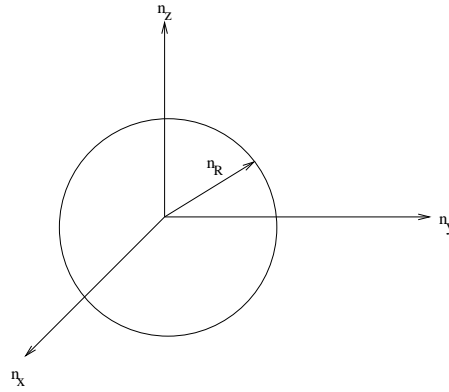

$$\text{Number of states from } k=0 \text{ to } k=k = \frac{1}{8} \times \frac{4}{3} \pi n_R^3 \times 2 \quad (7.14)$$

(Note : we multiply the relation by 2 because of the 2 spin states and $\frac{1}{8}$ because we only take the positive octant, i.e. n_x, n_y and n_z are all positive integers.)

$$\begin{aligned}\text{Number of states between } k \text{ and } k+dk &= \frac{1}{8} \times 4\pi k^2 dk \times 2 \times \left(\frac{L}{\pi}\right)^3 \\ &= \frac{V}{\pi^2} k^2 dk\end{aligned}\quad (7.15)$$

$$\begin{aligned}\text{Number of states between } \varepsilon \text{ and } \varepsilon+d\varepsilon \text{ is } g(\varepsilon)d\varepsilon &= \frac{V}{\pi^2} \frac{2m\varepsilon}{\hbar^2} \frac{dk}{d\varepsilon} d\varepsilon \\ &= \frac{V}{\pi^2} \frac{2m\varepsilon}{\hbar^2} \frac{m}{\hbar^2 k} d\varepsilon \\ &= \frac{V}{\pi^2} \frac{2m^2\varepsilon}{\hbar^4} \sqrt{\frac{\hbar^2}{2m\varepsilon}} d\varepsilon \\ &= \frac{V}{2\pi^2} \frac{(2m)^{\frac{3}{2}}}{\hbar^3} \varepsilon^{\frac{1}{2}} d\varepsilon \\ &= VC\varepsilon^{\frac{1}{2}} d\varepsilon\end{aligned}\quad (7.16)$$

where

$$C = \frac{1}{2\pi^2} \frac{(2m)^{\frac{3}{2}}}{\hbar^3}$$

Therefore,

$$\begin{aligned} N &= \sum_j n_j \\ &= \sum_j \frac{g_j}{e^{\beta(\varepsilon_j - \mu)} + 1} \\ &= \int_0^\infty \frac{g(\varepsilon)d\varepsilon}{e^{\beta(\varepsilon - \mu)} + 1} \end{aligned} \quad (7.17)$$

$$\begin{aligned} E &= \sum_j n_j \varepsilon_j \\ &= \sum_j \frac{\varepsilon_j g_j}{e^{\beta(\varepsilon_j - \mu)} + 1} \\ &= \int_0^\infty \frac{\varepsilon g(\varepsilon)d\varepsilon}{e^{\beta(\varepsilon - \mu)} + 1} \end{aligned} \quad (7.18)$$

We solve equation (7.17) for $\mu(N, T, V)$ and use μ in (7.18) to obtain ε . This is difficult to evaluate except at low T. We shall try to evaluate this in 2 cases

1. At $T = 0$

Probability of occupation of state of energy is $f_{F-D}(\varepsilon) = \frac{1}{e^{\beta(\varepsilon - \mu)} + 1}$ (7.19)

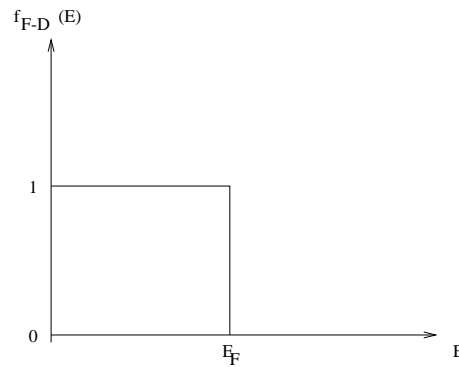

For

$$\mu(T = 0) = \varepsilon_F \quad \text{Fermi energy} \quad (7.20)$$

and

$$\begin{aligned} f_{F-D}(\varepsilon) &= 0 & \varepsilon > \varepsilon_F \\ f_{F-D}(\varepsilon) &= 1 & \varepsilon < \varepsilon_F \end{aligned}$$

Hence

$$\begin{aligned}
 N &= \int_0^{\infty} g(\varepsilon) f_{F-D}(\varepsilon) d\varepsilon \\
 &= \int_0^{\varepsilon_F} g(\varepsilon) d\varepsilon \\
 &= VC \int_0^{\varepsilon_F} \varepsilon^{\frac{1}{2}} d\varepsilon \\
 &= VC \frac{2}{3} \varepsilon_F^{\frac{3}{2}}
 \end{aligned} \tag{7.21}$$

and

$$\begin{aligned}
 \varepsilon_F &= \left[\frac{3N}{2V} \frac{2\pi^2 \hbar^3}{(2m)^{\frac{3}{2}}} \right]^{\frac{2}{3}} \\
 &= \left(\frac{3N\pi^2}{V} \right)^{\frac{2}{3}} \frac{\hbar^2}{2m} \\
 &= \frac{\hbar^2}{2m} k_F^2
 \end{aligned} \tag{7.22}$$

$$k_F = \left(\frac{3N\pi^2}{V} \right)^{\frac{1}{3}} \tag{7.23}$$

The meaning of Fermi energy is that all states below ε_F are occupied and all states above ε_F are unoccupied at $T = 0$.

At $T=0$, all electrons occupy the lowest possible state subject to the Exclusion Principle, so the states are filled until ε_F .

$$\begin{aligned}
 \text{Total Energy, } E &= \int_0^{\infty} g(\varepsilon) f_{F-D}(\varepsilon) d\varepsilon \\
 &= VC \int_0^{\varepsilon_F} \varepsilon^{\frac{3}{2}} d\varepsilon \\
 &= VC \frac{2}{5} \varepsilon_F^{\frac{5}{2}} \\
 &= \frac{3}{5} N \varepsilon_F
 \end{aligned} \tag{7.24}$$

2. At low T , $\frac{kT}{\varepsilon_F} \ll 1$, we want to find C_v and we know that the experimental value is proportional to T .

$$N = \int_0^{\infty} g(\varepsilon) f_{F-D}(\varepsilon) d\varepsilon$$

Therefore,

$$\begin{aligned}
 U &= \int_0^{\infty} \frac{\varepsilon g(\varepsilon) d\varepsilon}{e^{\beta(\varepsilon-\mu)} + 1} \\
 &= \int_0^{\infty} \frac{(\varepsilon - \varepsilon_F) g(\varepsilon) d\varepsilon}{e^{\beta(\varepsilon-\mu)} + 1} + \frac{\varepsilon_F g(\varepsilon) d\varepsilon}{e^{\beta(\varepsilon-\mu)} + 1} \\
 &= \int_0^{\infty} \frac{(\varepsilon - \varepsilon_F) g(\varepsilon) d\varepsilon}{e^{\beta(\varepsilon-\mu)} + 1} + N \varepsilon_F
 \end{aligned} \tag{7.25}$$

Then

$$\begin{aligned}
 C_v &= \left(\frac{\partial U}{\partial T}\right)_V \\
 &= - \int_0^\infty \frac{(\varepsilon - \varepsilon_F)g(\varepsilon)e^{\beta(\varepsilon-\mu)}}{(e^{\beta(\varepsilon-\mu)} + 1)^2} \times \left[(\varepsilon - \mu)\left(-\frac{1}{kT^2} - \frac{1}{kT} \frac{\partial \mu}{\partial T}\right)\right] d\varepsilon
 \end{aligned} \tag{7.26}$$

Since μ does not change much, so we assume $\frac{\partial \mu}{\partial T} = 0$ and $\mu = \varepsilon_F$,

$$C_v = \frac{1}{kT^2} \int_0^\infty \frac{(\varepsilon - \varepsilon_F)^2 e^{\beta(\varepsilon-\varepsilon_F)} VC \varepsilon^{\frac{1}{2}} d\varepsilon}{(e^{\beta(\varepsilon-\varepsilon_F)} + 1)^2} \tag{7.27}$$

Now,

$$\frac{\beta e^{\beta(\varepsilon-\varepsilon_F)}}{(e^{\beta(\varepsilon-\varepsilon_F)} + 1)^2} = -\frac{\partial f_{F-D}(\varepsilon)}{\partial \varepsilon} \tag{7.28}$$

The maximum occurs at $\varepsilon = \varepsilon_F$. The value drops to $\frac{1}{e}$ of the maximum value when $\varepsilon - \varepsilon_F \sim \pm kT$. So the function is sharp for small kT ($\ll \varepsilon_F$).

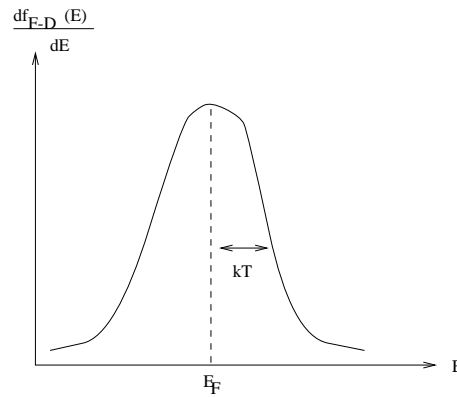

The contribution to the C_v integral comes mainly from values of ε near ε_F , i.e. $\varepsilon \approx \varepsilon_F$

$$\begin{aligned}
 C_v &= \frac{1}{kT^2} VC \varepsilon_F^{\frac{1}{2}} \int_0^\infty \frac{(\varepsilon - \varepsilon_F) e^{\beta(\varepsilon-\varepsilon_F)} d\varepsilon}{(e^{\beta(\varepsilon-\varepsilon_F)} + 1)^2} \\
 &= VC \varepsilon_F^{\frac{1}{2}} k^2 T \int_{\varepsilon_F}^\infty \frac{x^2 e^x dx}{(e^x + 1)^2} \quad \text{where } x = \beta(\varepsilon - \varepsilon_F)
 \end{aligned} \tag{7.29}$$

The lower limit can be extended to $-\infty$ because $kT \ll \varepsilon_F$.

$$\int_{-\infty}^\infty \frac{x^2 e^x dx}{(e^x + 1)^2} = \frac{\pi^2}{3} \tag{7.30}$$

Therefore

$$C_v = \frac{\pi^2}{3} k^2 T g(\varepsilon_F) \tag{7.31}$$

where $g(\varepsilon_F)$ is the density of states of Fermi level.

The physical picture :

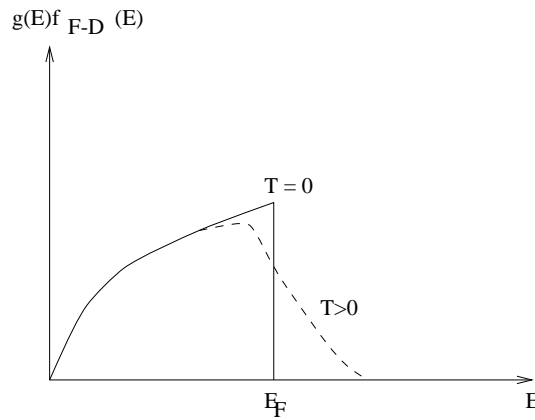

For $T = 0$: All states are occupied within $\varepsilon = \varepsilon_F$ is a truncated parabola.

For $T > 0$: We will expect electrons to gain energy kT . However, most electrons cannot gain kT because the states above them are already occupied. Only those electrons near ε_F can gain kT to move into unoccupied states. This results in a rounded-off cliff at ε_F .

An alternative estimate :

Number of electrons involved is $g(\varepsilon_F)kT$ and they gain kT . Therefore

$$\text{Energy of excitation} = g(\varepsilon_F)k^2T^2 \quad (7.32)$$

$$\begin{aligned} \text{Contribution to } C_v, \text{ heat capacity} &= \frac{\text{The number of electrons participating} \times \text{energy}}{\Delta T} \\ &= \frac{g(\varepsilon_F)kT \times kT}{T} \\ &= f(\varepsilon_F)k^2T \end{aligned} \quad (7.33)$$

Experimental result : $C_v \propto T$ for a fermi gas. The theory is in agreement but does not give the right constant of proportionality, and need to include effective mass of electron $m_e^* > m_e$ because electrons are not completely free but the lattice potential constrains them.

Chapter 8

Applications of Bose-Einstein Statistics

8.1 Introduction to Black Body Radiation

First, we discuss radiation in thermal equilibrium. The radiation is enclosed in vessel, and all the walls are at temperature T . The atoms in the wall will absorb and emit electromagnetic radiation. At equilibrium, the distribution of photons will follow the temperature T .

Second, in order to study the radiation, we assume a hole is cut in the chamber wall to emit some radiation. The hole is very small so that the equilibrium is not disturbed. This will approximate to a blackbody. The black body will also absorb all radiation falling on it. The radiation bounces inside the chamber until finally being absorbed.

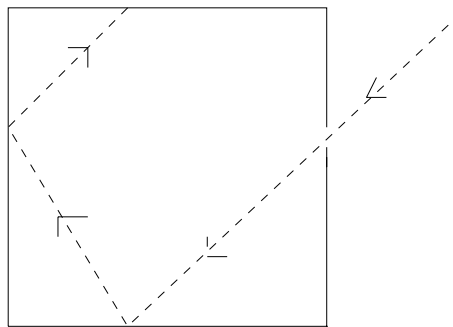

In this chapter, we will study black body radiation using statistical mechanics. We note that the photons have the following characteristics :

1. The photons have spin 1 (bosons) and they obey Bose-Einstein statistics.
2. The photons do not interact with one another.
3. The photons have zero rest mass and travel at c , the speed of light.
4. The photons satisfy the dispersion relation, $\omega = ck$, so,

$$\varepsilon = \hbar\omega = \hbar ck$$

8.2 Bose-Einstein Distribution

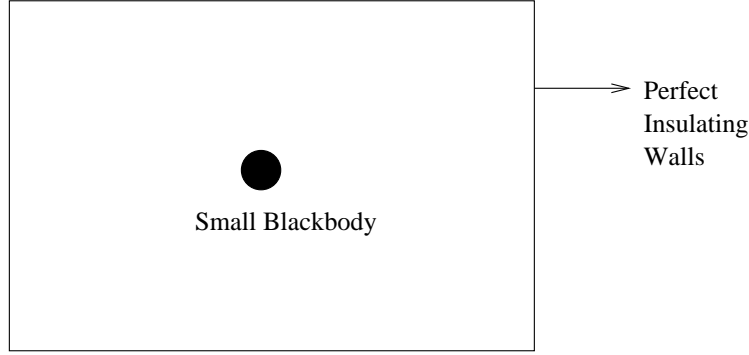

We consider a system of a small blackbody placed inside a chamber with perfect insulating walls. The features of the system are as follows :

1. The blackbody absorbs and emits radiation until thermal equilibrium is established.
2. The number of photons are not conserved because of absorption and re-emission. This implies that α and $\mu = 0$.
3. The blackbody is so small that heat capacity is negligible. The energy content of photons are not changed.

$$E = \sum_j n_j \varepsilon_j = \text{constant} \quad (\text{for the photons})$$

For bosons,

$$\Omega = \prod_j \frac{(n_j + g_j - 1)!}{n_j! (g_j - 1)!} \quad (8.1)$$

Maximise Ω subject to $E = \text{constant}$ only.

$$\begin{aligned} \ln \Omega &= \sum_j [\ln(n_j + g_j - 1)! - \ln n_j! - \ln(g_j - 1)!] \\ &= \sum_j (n_j + g_j - 1) \ln(n_j + g_j - 1) - (n_j + g_j - 1) - n_j \ln n_j + n_j - (g_j - 1) \ln(g_j - 1) + (g_j - 1) \\ &= \sum_j (n_j + g_j - 1) \ln(n_j + g_j - 1) - (g_j - 1) \ln(g_j - 1) - n_j \ln n_j \end{aligned} \quad (8.2)$$

$$d(\ln \Omega) = \sum_j \ln(n_j + g_j - 1) dn_j + dn_j - n_j \ln n_j - dn_j = 0 \quad (8.3)$$

$$\sum \ln\left(\frac{n_j + g_j - 1}{n_j}\right) dn_j = 0$$

$$\beta \sum_j dn_j \varepsilon_j = 0$$

Therefore

$$\sum [\ln(\frac{n_j + g_j - 1}{n_j}) - \beta \varepsilon_j] dn_j = 0 \quad (8.4)$$

So,

$$n_j = \frac{g_j}{e^{\beta \varepsilon_j} - 1} \quad (8.5)$$

for large g_j and n_j .

$$\text{Bose-Einstein function} = \frac{1}{e^{\beta \varepsilon_j} - 1} \quad (8.6)$$

Prove $\beta = \frac{1}{kT}$ by having the photon system in thermal contact with another system at temperature T and use walls that can exchange energy.

8.3 Planck's Radiation Formula

Consider photons enclosed in a box L^3 , standing electromagnetic waves result such that

$$\frac{n}{2} \lambda = L$$

Therefore

$$\begin{aligned} k_x &= \frac{2\pi}{\lambda_x} = \frac{n_x \pi}{L} \\ k_y &= \frac{2\pi}{\lambda_y} = \frac{n_y \pi}{L} \\ k_z &= \frac{2\pi}{\lambda_z} = \frac{n_z \pi}{L} \end{aligned}$$

For any photon with $\vec{k} = (k_x, k_y, k_z)$,

$$\frac{\omega^2}{c^2} = k^2 = k_x^2 + k_y^2 + k_z^2 \quad (8.7)$$

For any \vec{k} , there are 2 polarizations - 2 linear or 2 circular.

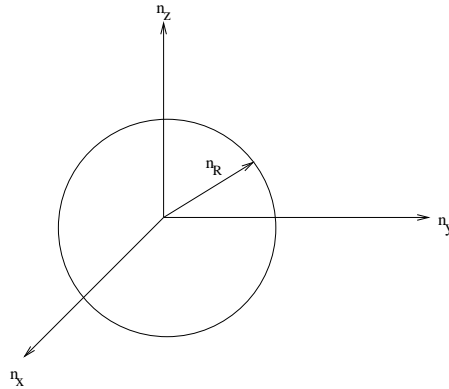

Therefore,

$$\begin{aligned} \text{Number of photon states for } k=0 \text{ to } k=k &= \frac{1}{8} \times \frac{4}{3} \pi n_R^3 \times 2 \\ &= \frac{\pi L^3}{3 \pi^3} k^3 \end{aligned} \quad (8.8)$$

since

$$n_R^2 = \frac{L^2}{\pi^2} k^2$$

$$\text{Number of photon states between } k \text{ and } k+dk = \frac{V}{\pi^2} k^2 dk \quad (8.9)$$

$$\begin{aligned} \text{Number of photon states between frequency range } \omega \text{ and } \omega+d\omega &= \frac{V \omega^2 d\omega}{\pi^2 c^2 c} \\ &= \frac{V \omega^2 d\omega}{\pi^2 c^3} \end{aligned} \quad (8.10)$$

The number of photons in frequency range ω and $\omega+d\omega$ is

$$\begin{aligned} N(\omega)d\omega &= (\text{Density of states}) \times (\text{Bose-Einstein function}) \\ &= \frac{V \omega^2 d\omega}{\pi^2 c^3 (e^{\beta \hbar \omega} - 1)} \end{aligned} \quad (8.11)$$

Thus the energy of the photons in the frequency range ω and $\omega+d\omega$ is

$$\hbar \omega N(\omega)d\omega = \frac{V \hbar}{\pi^2 c^3} \frac{\omega^3 d\omega}{e^{\beta \hbar \omega} - 1} \quad (8.12)$$

The energy density (per unit volume) in the frequency range is

$$u(\omega, T)d\omega = \frac{\hbar}{\pi^2 c^3} \frac{\omega^3 d\omega}{e^{\beta \hbar \omega} - 1} \quad (\text{Planck's formula}) \quad (8.13)$$

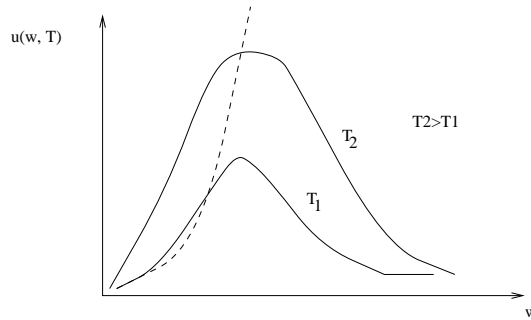

For $T_2 > T_1$, the maximum of $u(\omega, T)$ is given by :

$$\frac{e^{\beta \hbar \omega} 3\omega^2 - \omega^2 \beta \hbar e^{\beta \hbar \omega}}{(e^{\beta \hbar \omega} - 1)^2} = 0$$

$$\begin{aligned}\Rightarrow 3(e^{\beta\hbar\omega} - 1) &= \beta\hbar e^{\beta\hbar\omega} \\ \Rightarrow 3(e^x - 1) &= xe^x\end{aligned}$$

where $x = \beta\hbar\omega$

Solving numerically, $x \approx 3$, by neglecting (-1) , or more accurately, $x = 2.822$.

Therefore,

$$\frac{\hbar\omega_{max}}{kT} = 2.822 \quad (8.14)$$

$$\omega_{max} = \frac{2.822k}{\hbar}T \quad (\text{Wien's displacement law}) \quad (8.15)$$

or

$$\frac{2\pi c}{\lambda_{max}} = \frac{2.822k}{\hbar}T \quad (8.16)$$

$$\lambda_{max} = \frac{\hbar c}{2.822kT} \quad (8.17)$$

So, as T rises, the colour of the blackbody changes from red to blue :

$$\begin{aligned}\text{Total Energy Intensity, } u(T) &= \int_0^\infty u(\omega, T) d\omega \\ &= \frac{\hbar}{\pi^2 c^3} \int_0^\infty \frac{\omega^3 d\omega}{e^{\beta\hbar\omega} - 1} \\ &= \frac{\hbar}{\pi c^3} \frac{1}{\beta^4 \hbar^4} \int_0^\infty \frac{x^3 dx}{e^x - 1} \\ &= \frac{k^4 T^4}{\pi^2 c^3 \hbar^3} \frac{\pi^4}{15}\end{aligned} \quad (8.18)$$

Therefore

$$u(T) = aT^4 \quad (\text{Stefan-Boltzmann law}) \quad (8.19)$$

where

$$a = \frac{\pi^2 k^4}{15c^3 \hbar^3}$$

8.4 Radiation emitted by blackbody

Consider a tiny hole, ΔA , with photons coming from direction $(\theta \rightarrow \theta + d\theta, \phi \rightarrow \phi + d\phi)$, with a subtended solid angle $d\Omega$, where

$$\begin{aligned}d\Omega &= \frac{r \sin \theta d\phi r d\theta}{r^2} \\ &= \sin \theta d\theta d\phi\end{aligned}$$

The total solid angle = 4π .

The photons that will pass through in time Δt are located in a parallelepiped of length $c\Delta t$.

The volume of the parallelepiped is $dA \times c\Delta t \cos \theta$.

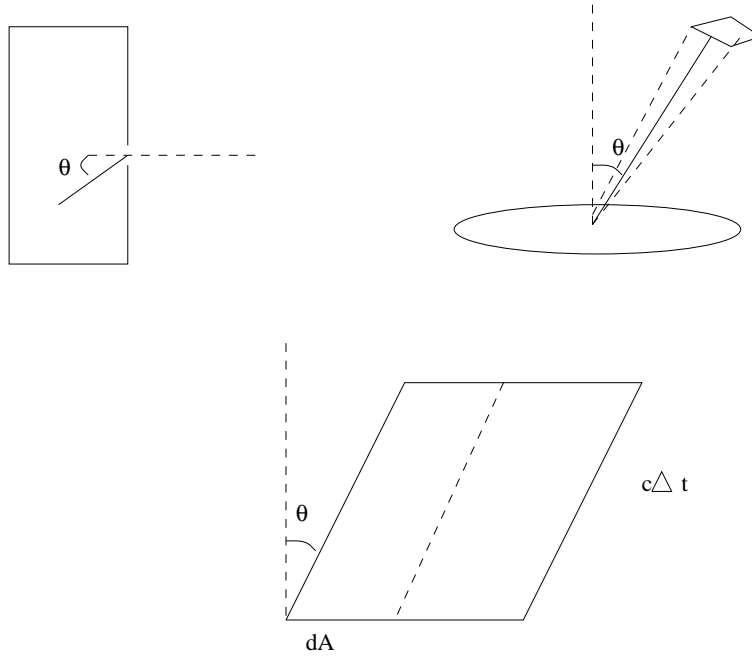

Therefore,

No. of photons passing per unit time from direction $(\theta \rightarrow \theta + d\theta, \phi \rightarrow \phi + d\phi)$ with a frequency range ω to $\omega + d\omega$

$$\begin{aligned}
 &= \frac{\text{Volume of Parallelepiped}}{\Delta t} \times \text{Fractional solid angle} \times \text{Number density in frequency interval} \\
 &= dAc \cos \theta \times \frac{d\Omega}{4\pi} \times \frac{N(\omega)d\omega}{V}
 \end{aligned}$$

Therefore, the total energy radiated per unit time in frequency interval ω to $\omega + d\omega$

$$\begin{aligned}
 &= \int_0^{2\pi} d\phi \int_0^{\frac{\pi}{2}} \sin \theta d\theta \frac{dAc \cos \theta}{4\pi} \times \hbar\omega \frac{N(\omega)d\omega}{V} \\
 &= \frac{1}{4} c\hbar\omega dA \frac{N(\omega)d\omega}{V} \\
 &= \frac{1}{4} cu(\omega, T)dAd\omega
 \end{aligned}$$

Therefore

Power radiated per unit area in frequency interval from ω to $\omega + d\omega$

$$= \frac{1}{4} cu(\omega, T)d\omega$$

$$\begin{aligned}\text{Total power radiated} &= \frac{1}{4}c \int_0^\infty u(\omega, T)d\omega \\ &= \frac{1}{4}caT^4 \\ &= \sigma T^4\end{aligned}$$

where $a = \frac{\pi^2 k^4}{15c^3 \hbar^3}$.

Therefore,

$$\begin{aligned}\sigma &= \frac{\pi^2 k^4}{60c^2 \hbar^3} \\ &= 5.67 \times 10^{-8} \text{ W m}^{-2} \text{ K}^{-4}\end{aligned}$$

Chapter 9

The Classical Limit

9.1 The Classical Regime

In the classical regime, there is a lack of discreteness, we consider the continuous variable ε rather than the discrete energy ε_r .

The energy spacing is $\Delta\varepsilon \ll kT$, and $\langle n_r \rangle \ll 1$ which means that there are many unoccupied states, which are averaged over time.

In the Fermi-Dirac or Bose Einstein statistics, the classical regime is only satisfied if

$$\frac{1}{e^{\beta(\varepsilon_r - \mu)} \pm 1} \ll 1$$

i.e.

$$e^{\beta(\varepsilon_r - \mu)} \gg 1$$

so that

$$\begin{aligned} \langle n_r \rangle_{\text{F-D, B-E}} &\approx e^{-\beta(\varepsilon_r - \mu)} \\ &= e^{\beta\mu} e^{-\beta\varepsilon_r} \quad \text{M-B distribution} \end{aligned}$$

So all the 3 distributions (Maxwell-Boltzmann, Fermi-Dirac and Bose-Einstein) distributions approximate to Maxwell-Boltzmann distributions in the classical regime.

According to the Maxwell-Boltzmann statistics,

$$\langle n_r \rangle_{\text{M-B}} = \frac{N}{Z} e^{-\beta\varepsilon_r} \ll 1 \quad (9.1)$$

for all r , including $r = 0$.

So we require $\frac{N}{Z} \ll 1$, since $\varepsilon_0 \rightarrow 0$ for ground state.

9.2 Monatomic Gas

For monatomic gas,

$$Z = \frac{V}{h^3} \left(2\pi m k T \right)^{\frac{3}{2}}$$

so,

$$\frac{N h^3}{V} \left(\frac{1}{2\pi m k T} \right)^{\frac{3}{2}} \ll 1$$

$$T \gg \left(\frac{N}{V} \right)^{\frac{2}{3}} \frac{h^2}{2\pi m k}$$

The conditions are high temperature, T and low density $\frac{N}{V}$, and high mass, m .

Assume the energy is equipartitioned,

$$\begin{aligned} \varepsilon &= \frac{3}{2} k T && \text{(for each atom)} \\ &= \frac{p^2}{2m} \end{aligned}$$

So,

$$p = \sqrt{2m\varepsilon} = \frac{h}{\lambda_{dB}} \quad \text{(in QM terms)} \quad (9.2)$$

Then

$$\begin{aligned} \left(\frac{1}{2\pi m k T} \right)^{\frac{3}{2}} &= \left(\frac{1}{\frac{4\pi}{3} m \varepsilon} \right)^{\frac{3}{2}} \\ &= \left(\frac{3}{2\pi} \right)^{\frac{3}{2}} \frac{1}{p^3} \\ &= \left(\frac{3}{2\pi} \right)^{\frac{3}{2}} \left(\frac{\lambda_{dB}}{h} \right)^3 \end{aligned} \quad (9.3)$$

and

$$\frac{N}{V} \left(\frac{3}{2\pi} \right)^{\frac{3}{2}} \lambda_{dB}^3 \ll 1$$

i.e.

$$\lambda_{dB} \ll \left(\frac{2\pi}{3} \right)^{\frac{1}{2}} \left(\frac{V}{N} \right)^{\frac{1}{3}} = \left(\frac{2\pi}{3} \right)^{\frac{1}{2}} l_0$$

where l_0 is the average separation between atoms.

Examples :

1. He gas :

$$\frac{N}{V} = 10^{20} \text{ per } cm^3$$

so $l_0 = 2 \times 10^{-7} cm$
 At $T = 273 \text{ K}$, and

$$m = \frac{4}{6 \times 10^{23}} g$$

so $\lambda_{dB} = 8 \times 10^{-9} \text{ cm} \ll l_0$. Hence Maxwell-Boltzmann distribution is applicable.

For liquid He at $T = 4 \text{ K}$,

$$\frac{N}{V} = 2 \times 10^{22} \text{ per } cm^3$$

so $l_0 = 4 \times 10^{-8} cm$.

Since $\lambda_{dB} > l_0$, so Bose Einstein statistics apply.

2. For conduction electrons :

Assume 1 electron per atom,

$$\frac{N}{V} \sim 10^{23} \text{ per } cm^3$$

hence

$$l_0 \sim 2 \times 10^{-8} cm$$

For $m = 9.1 \times 10^{-31} \text{ kg}$ and $T = 273 \text{ K}$, $\lambda_{dB} > l_0$, so Fermi-Dirac statistics apply.

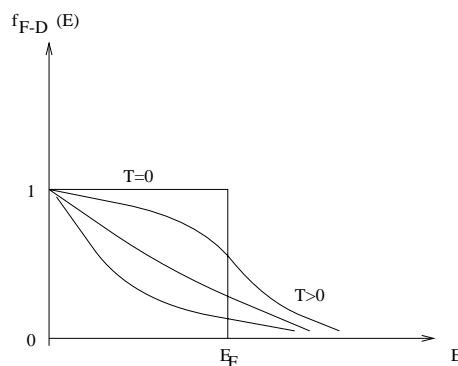
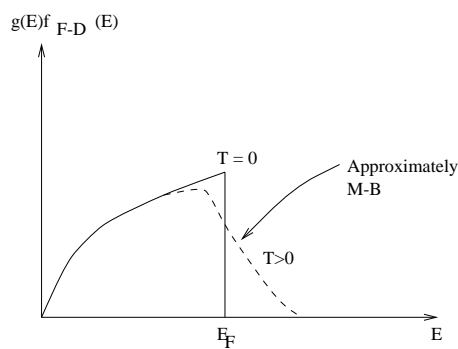

Note that

$$n(\varepsilon) \propto \varepsilon^{\frac{1}{2}} e^{-\beta\varepsilon}$$

for M-B distributions.

9.3 Gibbs Paradox

For classical ideal gas, we assume the atoms to be distinguishable. Now we mix the volumes of identical atoms.

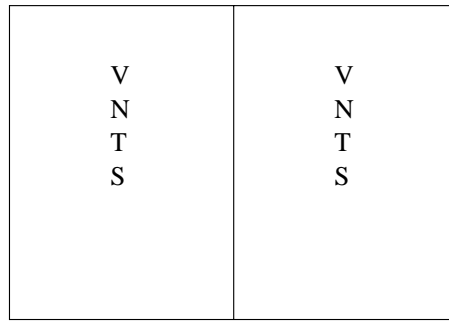

$$\begin{aligned}
 S &= \frac{U}{T} + Nk \ln Z \\
 &= \frac{3}{2}Nk + Nk \left[\ln V + \frac{3}{2} \ln T + \frac{3}{2} \ln \left(\frac{2\pi mk}{h^2} \right) \right]
 \end{aligned} \tag{9.4}$$

Suppose now $N \rightarrow 2N$, $V \rightarrow 2V$, we expect $S \rightarrow 2S$.

However,

$$\begin{aligned}
 S &= \frac{3}{2}(2N)k + (2N)k \left[\ln 2V + \frac{3}{2} \ln T + \frac{3}{2} \ln \left(\frac{2\pi mk}{h^2} \right) \right] \\
 &= 2S_{\text{old}} + 2Nk \ln 2
 \end{aligned} \tag{9.5}$$

The problem lies with distinguishability and overcounting. Hence we use a corrected Ω .

$$\begin{aligned}
 \text{Corrected } \Omega &= \frac{\Omega_{\text{old}}}{N!} \\
 &= \prod_j \frac{g_j^{n_j}}{n_j!}
 \end{aligned} \tag{9.6}$$

Therefore,

$$\begin{aligned}
 \text{Corrected } S &= k \ln \text{Corrected } \Omega - k(N \ln N - N) \\
 &= \frac{5}{2}Nk + Nk \left[\ln \left(\frac{V}{N} \right) + \frac{3}{2} \ln T + \frac{3}{2} \ln \left(\frac{2\pi mk}{h^2} \right) \right]
 \end{aligned} \tag{9.7}$$

Then for $N \rightarrow 2N$, $V \rightarrow 2V$,

$$\begin{aligned} S &= \frac{5}{2}(2N)k + 2Nk \left[\ln \left(\frac{2V}{2N} \right) + \frac{3}{2} \ln T + \frac{3}{2} \ln \left(\frac{2\pi mk}{h^2} \right) \right] \\ &= 2S_{\text{old}} \end{aligned} \tag{9.8}$$

Chapter 10

Kinetic Theory of Gases

10.1 Introduction

Consider the distribution (for e.g. velocity, momentum, position, energy, etc) of system of gas molecules in thermal equilibrium.

At thermal equilibrium, the momentum and spatial coordinates are independent of each other, i.e. a molecule in any position (x,y,z) can have any momentum (p_x, p_y, p_z).

For the Hamiltonian :

1. The kinetic energy (KE) terms are determined by p_x, p_y and p_z .
2. The potential energy (PE) terms are determined by x, y and z.

The Boltzmann law applies to every coordinate in the Hamiltonian.

For example,

1. The probability that x-momentum which lies between p_x and p_x+dp_x is :

$$P[p_x]dp_x = Ae^{\frac{-p_x^2}{2mkT}} dp_x \quad (10.1)$$

where

$$A \int_{-\infty}^{\infty} e^{\frac{-p_x^2}{2mkT}} dp_x = 1 \quad (10.2)$$

2. The probability that x-velocity lies between v_x and v_x+dv_x is :

$$P[v_x]dv_x = A'e^{\frac{-mv_x^2}{2kT}} dv_x \quad (10.3)$$

where

$$A' \int_{-\infty}^{\infty} e^{\frac{-mv_x^2}{2kT}} dv_x = 1 \quad (10.4)$$

3. The probability that the molecule is found between x and $x+dx$ is :

$$P[x]dx = B e^{-\frac{V(x)}{kT}} dx \quad (10.5)$$

where

$$B \int_{-\infty}^{\infty} e^{-\frac{V(x)}{kT}} dx = 1 \quad (10.6)$$

We concentrate on the momentum and velocity distributions, hence we do not require the interaction potential except for establishing thermal equilibrium.

For graphs of $P[p_x]$ or $P[v_x]$: the gaussian curves centred at zero.

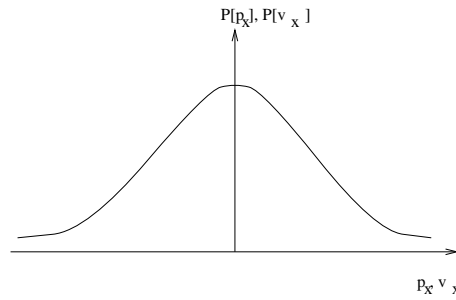

For speed distribution : $P[c] dc$ where $c^2 = v_x^2 + v_y^2 + v_z^2$.

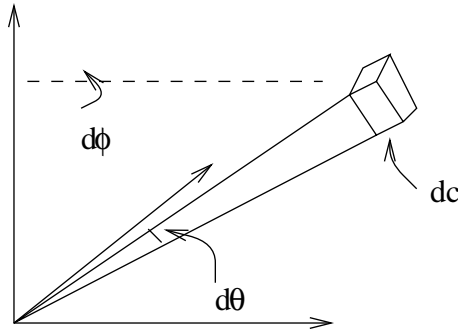

$$\begin{aligned} P[v_x, v_y, v_z] dv_x dv_y dv_z &= P[v_x] dv_x P[v_y] dv_y P[v_z] dv_z \\ &= \left(\frac{m}{2\pi kT} \right)^{\frac{3}{2}} e^{-\frac{mv_x^2}{2kT}} e^{-\frac{mv_y^2}{2kT}} e^{-\frac{mv_z^2}{2kT}} dv_x dv_y dv_z \\ &= \left(\frac{m}{2\pi kT} \right)^{\frac{3}{2}} e^{-\frac{mc^2}{2kT}} dc (c d\theta) (c \sin\theta d\phi) \end{aligned} \quad (10.7)$$

Integrating over all angles :

$$P[c]dc = 4\pi \left(\frac{m}{2\pi kT} \right)^{\frac{3}{2}} e^{-\frac{mc^2}{2kT}} c^2 dc \quad (10.8)$$

Hence, we can calculate :

1. Most probable speed, c_{max} :

For c_{max} , put

$$\frac{dP[c]}{dc} = 0 \Rightarrow c_{max} = \left(\frac{2kT}{m}\right)^{\frac{1}{2}} \quad (10.9)$$

2. Mean speed \bar{c} :

$$\bar{c} = \int_0^{\infty} cP[c]dc = \left(\frac{8kT}{\pi m}\right)^{\frac{1}{2}} \quad (10.10)$$

3. Mean square speed, \bar{c}^2 :

$$\bar{c}^2 = \int_0^{\infty} c^2P[c]dc = \frac{3kT}{m} \quad (10.11)$$

4. Root mean square speed, $\sqrt{\bar{c}^2}$:

$$\sqrt{\bar{c}^2} = \left(\frac{3kT}{m}\right)^{\frac{1}{2}} \quad (10.12)$$

5. Mean kinetic energy (KE) :

$$\text{Mean KE} = \frac{1}{2}m\bar{c}^2 = \frac{3}{2}kT \quad (10.13)$$

Note :

$$\begin{aligned} \bar{c}^2 &= \bar{v}_x^2 + \bar{v}_y^2 + \bar{v}_z^2 \\ &= 3\bar{v}_x^2 \end{aligned} \quad (10.14)$$

so

$$\bar{v}_x^2 = \frac{kT}{m} \quad (10.15)$$

10.2 Number of impacts on Area A of a wall

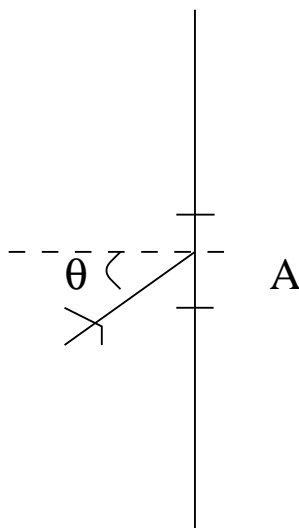

The distribution of speeds : $P[c] dc$

The fraction of molecules travelling in direction $(\theta \rightarrow \theta + d\theta, \phi \rightarrow \phi + d\phi)$ is

$$\frac{cd\theta c \sin\theta d\phi}{4\pi c^2} = \frac{\sin\theta d\theta d\phi}{4\pi} \quad (10.16)$$

The fraction that will reach A in time Δt for above direction

$$= \frac{Ac \cos\theta \Delta t}{V} \quad (10.17)$$

where V is the volume of the gas.

Therefore,

Number of impacts on area A in time Δt

$$= \iiint NP[c]dc \frac{\sin\theta d\theta d\phi}{4\pi} \frac{Ac \cos\theta \Delta t}{V} \quad (10.18)$$

Number of impacts on unit area per unit time

$$\begin{aligned} &= \frac{N}{4\pi V} \int_0^\infty cP[c]dc \int_0^{\frac{\pi}{2}} \sin\theta \cos\theta d\theta \int_0^{2\pi} d\phi \\ &= \frac{N}{4\pi V} \bar{c} \frac{1}{2} (2\pi) \\ &= \frac{1}{4} n \bar{c} \end{aligned} \quad (10.19)$$

where the number density, $n = \frac{N}{V}$.

10.3 Effusion of molecules

The number of molecules with speeds $c \rightarrow c + dc$ from direction $(\theta \rightarrow \theta + d\theta, \phi \rightarrow \phi + d\phi)$ imping a area in time Δt is

$$\frac{N}{4\pi V} cP[c]dc \sin\theta d\theta d\phi A \Delta t$$

The distribution is proportional to $c P[c] dc$.

The mean speed of escape, \bar{c}_e :

$$\begin{aligned} \bar{c}_e &= \frac{\int c^2 P[c]dc}{\int cP[c]dc} \\ &= \frac{\frac{3kT}{m}}{\left(\frac{8kT}{\pi m}\right)^{\frac{1}{2}}} \\ &= \left(\frac{9\pi kT}{8m}\right)^{\frac{1}{2}} \end{aligned} \quad (10.20)$$

Number of molecules escaping per unit time per unit area

$$\begin{aligned} \frac{1}{4}m\bar{c} &= \frac{p}{kT} \left(\frac{8kT}{\pi m} \right)^{\frac{1}{2}} \\ &\propto \frac{1}{m^{\frac{1}{2}}} \end{aligned} \quad (10.21)$$

So, the smaller molecules escapes (effuses) faster.

10.4 Mean Free Path, λ

The free path is defined as the distance between collisions. It is not all equal, for some are longer and some are shorter. The more probable the collision, the shorter is the free path.

The distribution of free path :

Probability that free path in between x and $x+dx \propto e^{-\frac{x}{\lambda}} \frac{dx}{\lambda}$.

We can prove this by a self consistent argument :

Probability that collision occurs between x and $x+dx$

= (Probability of no collision from 0 to x) \times (Probability of collisions in dx)

Comparing with the above equation, we write

$$\text{Probability of no collision in } dx = e^{-\frac{dx}{\lambda}} \quad (10.22)$$

$$\text{Probability of collision in } dx = \frac{dx}{\lambda} \quad (10.23)$$

According to (10.22),

$$\text{the probability of no collision in } dx = e^{-\frac{dx}{\lambda}} \quad (10.24)$$

Then,

$$\begin{aligned} \text{Probability of collision in } dx &= 1 - e^{-\frac{dx}{\lambda}} \\ &= 1 - \left(1 - \frac{dx}{\lambda} \right) + \dots \\ &\approx \frac{dx}{\lambda} \end{aligned} \quad (10.25)$$

which agrees with (10.23).

So the argument is self consistent. Also, we see that

$$\int_0^{\infty} e^{-\frac{x}{\lambda}} \frac{dx}{\lambda} = 1 \quad (10.26)$$

which is as required for probability.

Therefore,

$$\begin{aligned} \text{Mean free path} &= \int_0^{\infty} x e^{-\frac{x}{\lambda}} \frac{dx}{\lambda} \\ &= [-x e^{-\frac{x}{\lambda}}]_0^{\infty} + \int_0^{\infty} e^{-\frac{x}{\lambda}} dx \\ &= [-\lambda e^{-\frac{x}{\lambda}}]_0^{\infty} \\ &= \lambda \end{aligned} \quad (10.27)$$

10.5 Collision cross-section, σ

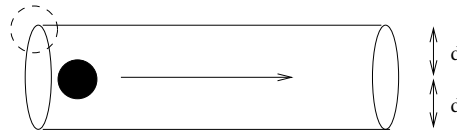

The moving gas molecules sweeps out a cylinder of cross section :

$$\sigma = \pi d^2 \quad (10.28)$$

where d is the diameter of the each molecule.

$$\text{Average volume occupied by each molecule} = \frac{V}{N} = \frac{1}{n} \quad (10.29)$$

So,

$$\begin{aligned} \text{Mean free path, } \lambda &= \frac{V}{N} \times \frac{1}{\pi d^2} \\ &= \frac{1}{n\pi d^2} \end{aligned} \quad (10.30)$$

Taking in account of the motion of gas molecules,

$$\lambda = \frac{1}{\sqrt{2} n \sigma} \quad (10.31)$$

At stp, $\lambda \sim 7 \times 10^{-8}$ m. At 10^{-6} mbar, $\lambda \sim 5$ m.